

NEWPORT BATH

Features

- Solid brass construction
- 3/4" NPT connections
- Quarter-turn washerless ceramic disc 3/4" valve cartridges.
- Quick Conect Deck Spout Adapter
- Requires Newport Brass Wall Mount Tub Trim (many options available, sold-separately)

Deck Tub Rough Valve

1-502



Codes / Standards Compliance

Meets or exceeds the following at date of manufacture:

- ASME A112.18.1/CSA B125.1-18
- IAMPO/cUPC
- IPC
- All applicable US Federal and State material regulations

Colors / Finishes

- 10B: Oil Rubbed Bronze
- 15: Polished Nickel
- 15S: Satin Nickel - PVD
- 26: Polished Chrome
- Other: Refer to the Newport Brass catalog for additional color/finish options.



Specified Model

Model	Description	Colors Finishes
1-502	Quick Conect Deck Tub Rough Valve	<input type="checkbox"/> NA

Product Specification:

Add "Color / Finish" suffix to Model number, below.

The deck mount valve for tub installations shall be made of solid brass construction. Valve body shall have 3/4" NPT connections. Valve body shall incorporate quarter-turn washerless ceramic disc valve cartridges. Rough Valve for deck mount trim shall also include a quick-connect spout fitting. Rough Valve for deck mount trim installations shall be Newport Brass Model 1-502.

1-502

PRODUCT DIMENSIONS *(Units are in inches)*

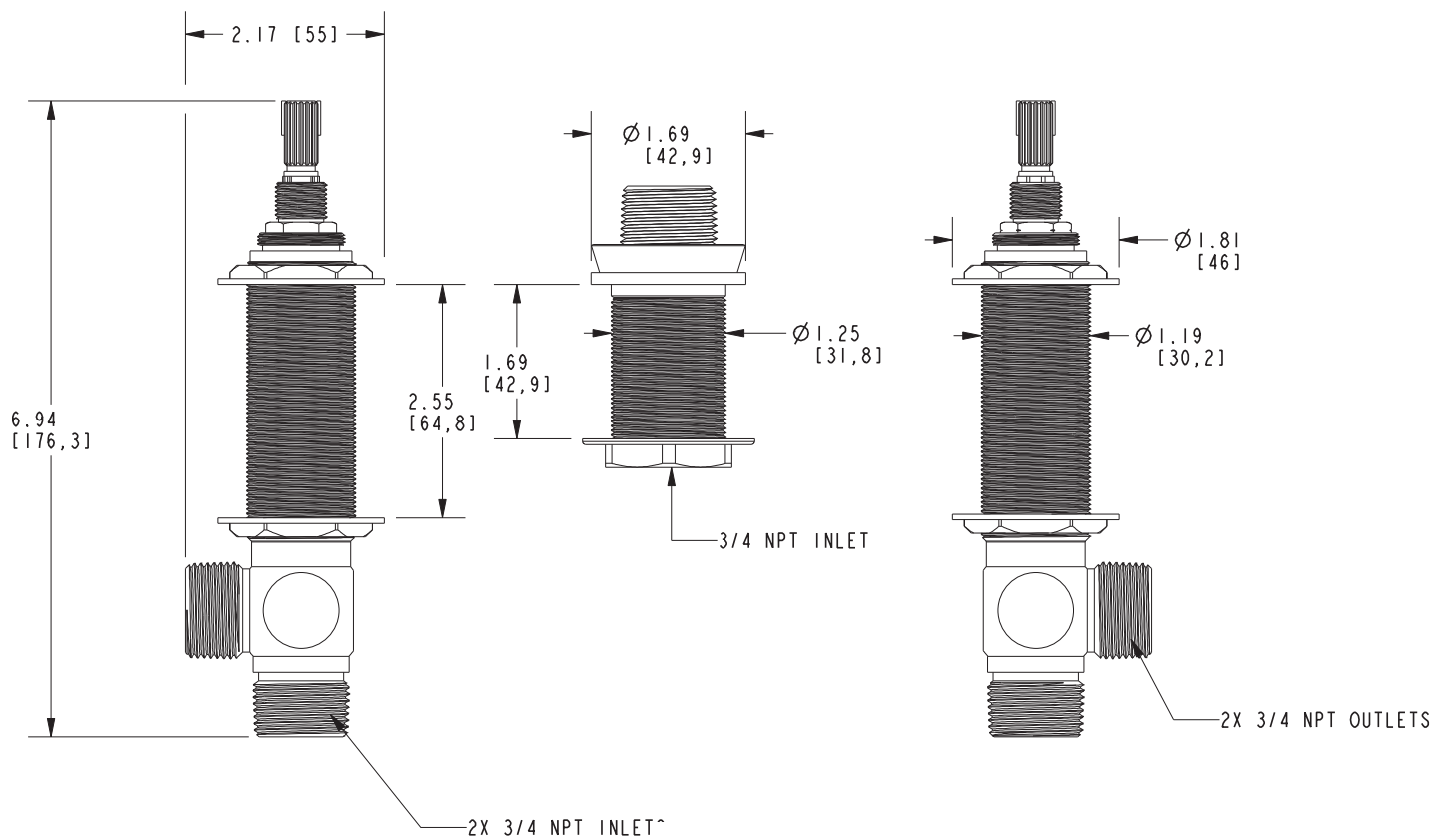

Newport Deck Tub Rough Valve 1-502