

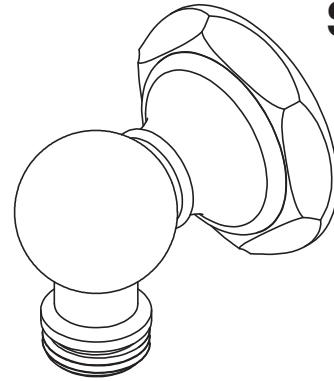

Features

- Over 30 finishes including 14 PVD finishes
- Solid brass construction
- 1/2" NPT (female) inlet connection
- 1/2" NPSM (male) outlet connection

SH-10-47



Codes/Standards Applicable

Meets or exceeds the following at date of manufacture:

- ASME A112.18.1/CSA B125.1

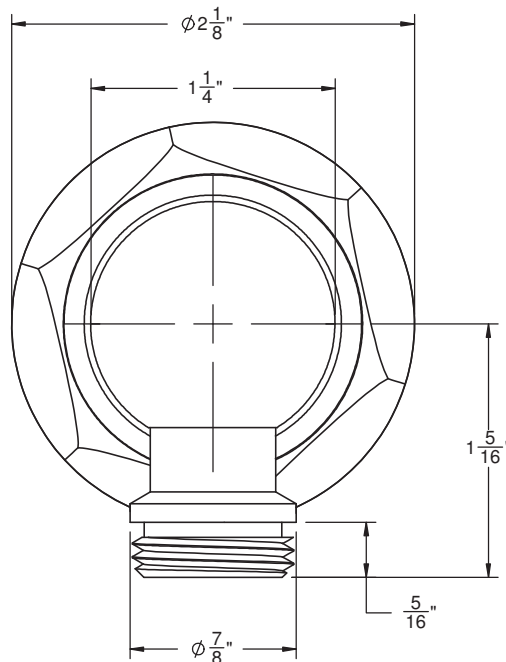
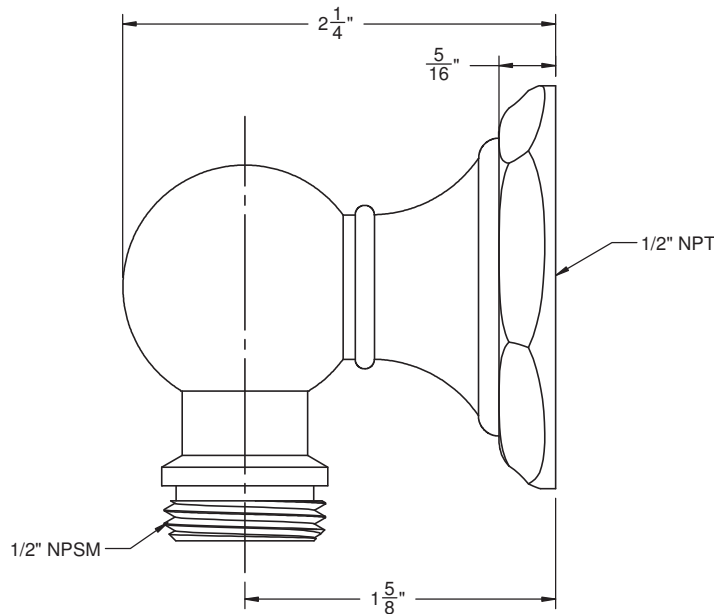

ALL DIMENSIONS SHOWN TO NEAREST 1/16"



California Faucets®

SLIDE BAR

TRADITIONAL HANDSHOWER SLIDE BAR

Features

- Over 30 finishes including 15 PVD finishes
- All brass construction
- Matching handle & escutcheon for all California Faucets series
- Bar pivots 180° without loosening slide handle
- Handshower holder slides up and down on bar
- Handshower holder angle is adjustable
- Handshower holder accepts conical end of hose
- Right or left handed based on installation
- Includes all mounting hardware

Codes/Standards Applicable

Product meets or exceeds the following:

- ASME A112.18.1/CSA B125.1
- ADA (all lever handles)

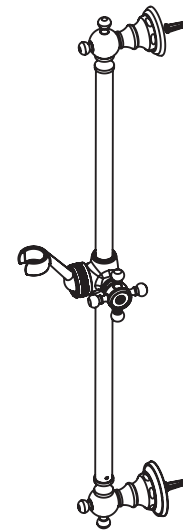

SB-XX

XX = SERIES HANDLE

TABLE (ALL DIMENSIONS SHOWN IN INCHES)				
SERIES	A	B	C	D
30	$2\frac{5}{16}$	$2\frac{7}{16}$	$3\frac{9}{16}$	3
30K, 30F	$2\frac{5}{16}$	$2\frac{7}{16}$	$3\frac{9}{16}$	$3\frac{1}{8}$
30X, 30XK, 30XF	$2\frac{5}{16}$	$2\frac{7}{16}$	$3\frac{9}{16}$	$1\frac{1}{2}$
33	$2\frac{1}{8}$	$2\frac{9}{16}$	$3\frac{11}{16}$	$3\frac{1}{2}$
34	$2\frac{1}{8}$	$2\frac{9}{16}$	$3\frac{11}{16}$	$1\frac{1}{8}$
35	$2\frac{1}{8}$	$2\frac{9}{16}$	$3\frac{11}{16}$	$3\frac{7}{16}$
36	$2\frac{1}{8}$	$2\frac{9}{16}$	$3\frac{11}{16}$	$3\frac{1}{16}$
38	$2\frac{7}{8}$	$2\frac{11}{16}$	$3\frac{3}{4}$	$2\frac{7}{8}$
40	$2\frac{13}{16}$	$2\frac{5}{8}$	$3\frac{3}{4}$	$3\frac{1}{4}$
42	$2\frac{13}{16}$	$2\frac{5}{8}$	$3\frac{3}{4}$	$2\frac{15}{16}$
44	2	$2\frac{7}{8}$	$4\frac{1}{16}$	$2\frac{15}{16}$
45	$2\frac{5}{16}$	$2\frac{5}{16}$	$3\frac{3}{8}$	3
46	$2\frac{5}{16}$	$2\frac{3}{8}$	$3\frac{1}{2}$	$3\frac{7}{16}$
47	$2\frac{5}{16}$	$2\frac{3}{8}$	$3\frac{1}{2}$	$3\frac{1}{8}$
48	$2\frac{5}{16}$	$2\frac{5}{16}$	$3\frac{13}{16}$	$3\frac{1}{8}$
48X	$2\frac{5}{16}$	$2\frac{5}{16}$	$3\frac{13}{16}$	$1\frac{1}{2}$
50	$2\frac{9}{16}$	$2\frac{5}{16}$	$3\frac{3}{8}$	$2\frac{13}{16}$
51	$3\frac{1}{4}$	$2\frac{11}{16}$	$3\frac{13}{16}$	$1\frac{1}{16}$
55	$2\frac{13}{16}$	$2\frac{5}{8}$	$3\frac{3}{4}$	$3\frac{5}{16}$
59	$2\frac{13}{16}$	$2\frac{13}{16}$	$3\frac{7}{8}$	3
60	$2\frac{1}{8}$	$2\frac{5}{16}$	$3\frac{7}{16}$	$1\frac{5}{16}$
63	$2\frac{5}{16}$	$2\frac{3}{8}$	$3\frac{1}{2}$	$1\frac{9}{16}$
64	$2\frac{13}{16}$	$2\frac{13}{16}$	$3\frac{7}{8}$	$3\frac{5}{16}$
67	$2\frac{1}{8}$	$2\frac{5}{16}$	$3\frac{7}{16}$	$1\frac{1}{8}$
68	$2\frac{1}{8}$	$2\frac{9}{16}$	$3\frac{11}{16}$	$3\frac{3}{8}$
69	$2\frac{1}{8}$	$2\frac{9}{16}$	$3\frac{11}{16}$	$3\frac{1}{2}$

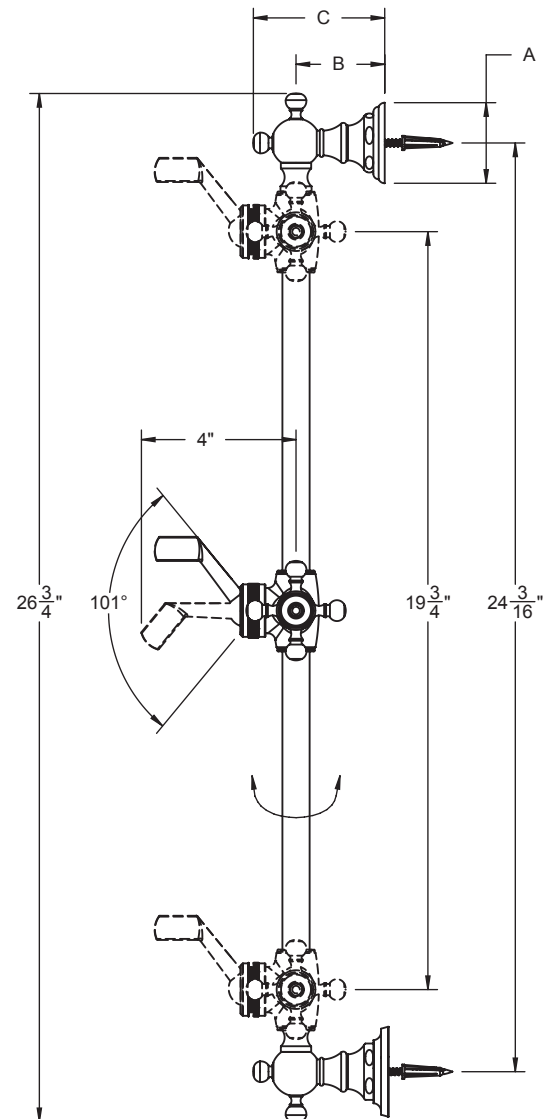
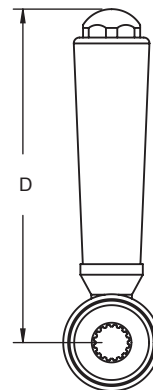
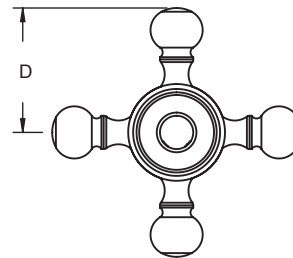

ALL DIMENSIONS SHOWN TO NEAREST 1/16"



California Faucets®

Handshower

HANDSHOWER HOSE

Features

- 1/2" FIP inlet
- 1/2" FIP outlet
- Double spiral out hose for added strength
- Solid brass construction
- Over 30 finishes include 16 PVD finishes

Codes/Standards Applicable

Meets or exceeds the following at date of manufacture:

- ASME A112.18.1/CSA B125.1

HS-68

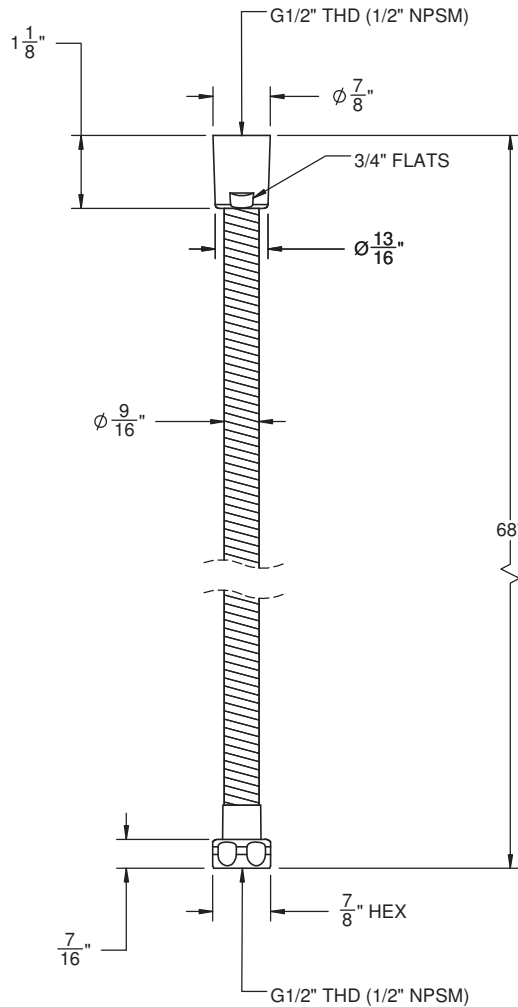

ALL DIMENSIONS SHOWN TO NEAREST 1/16"