



41180 Raintree Court
Murrieta, CA 92562
1-888-304-0660
www.waterstoneco.com

ITEM NO: **6300**

STYLE: **HAMPTON**

INTENDED USE: BRIDGE FAUCET

CUSTOMER NAME:

JOB NO:

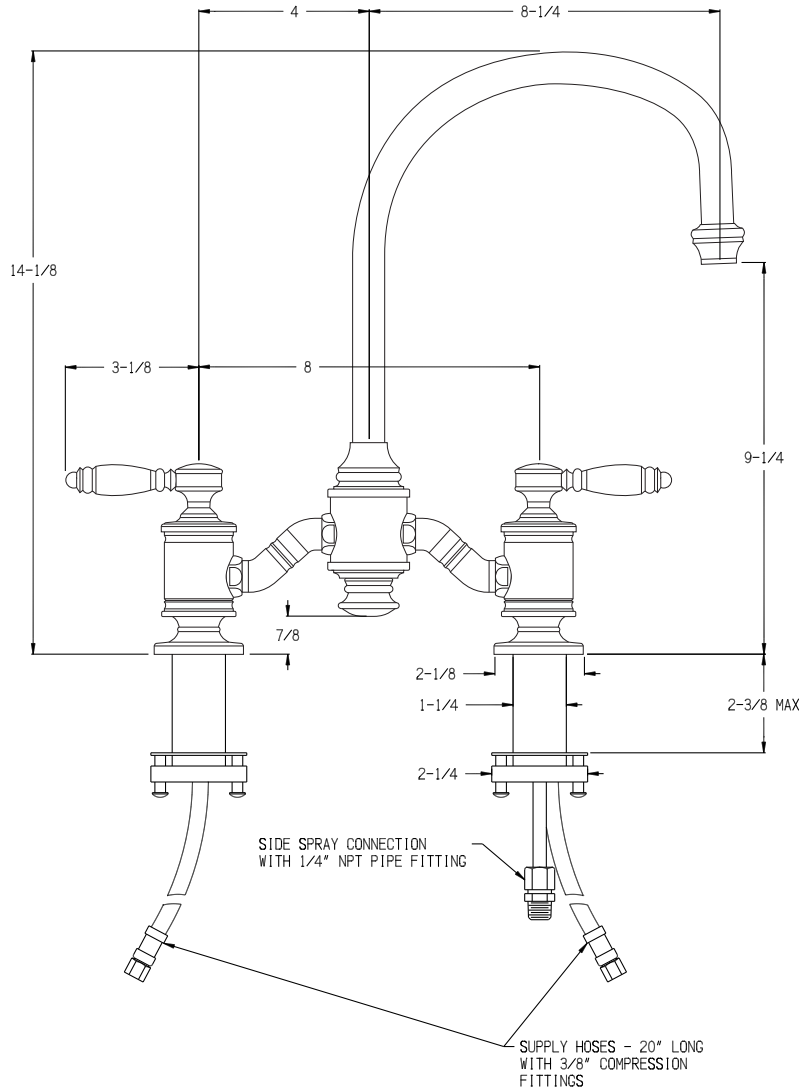

DIMENSIONS MAY VARY AND ARE SUBJECT TO CHANGE. NO RESPONSIBILITY IS ASSUMED FOR USE OF SUPERCEDED OR VOIDED DATA

Technical Specifications

- Compatible with Reverse Osmosis
- Solid brass construction.
- 360 degree swivel spout.
- Aerated stream.
- 4 handle caps included: 2 plain finish caps and 2 ceramic hot and cold caps.
- 1.75 gpm maximum flow rate.
- Diverter equipped for connection to optional side spray.
- Reinforced braided connection hoses.

Codes/Standards Applicable

Specified model meets or exceeds the following:

- ASME A112.18.1
- CSA B125.1
- NSF 61
- CALGreen

DATE: 1-9-14



MADE IN THE USA