

SAMUEL HEATH

Product Number: N34

Description: Soap holder



Finishes Available



Specification Drawing

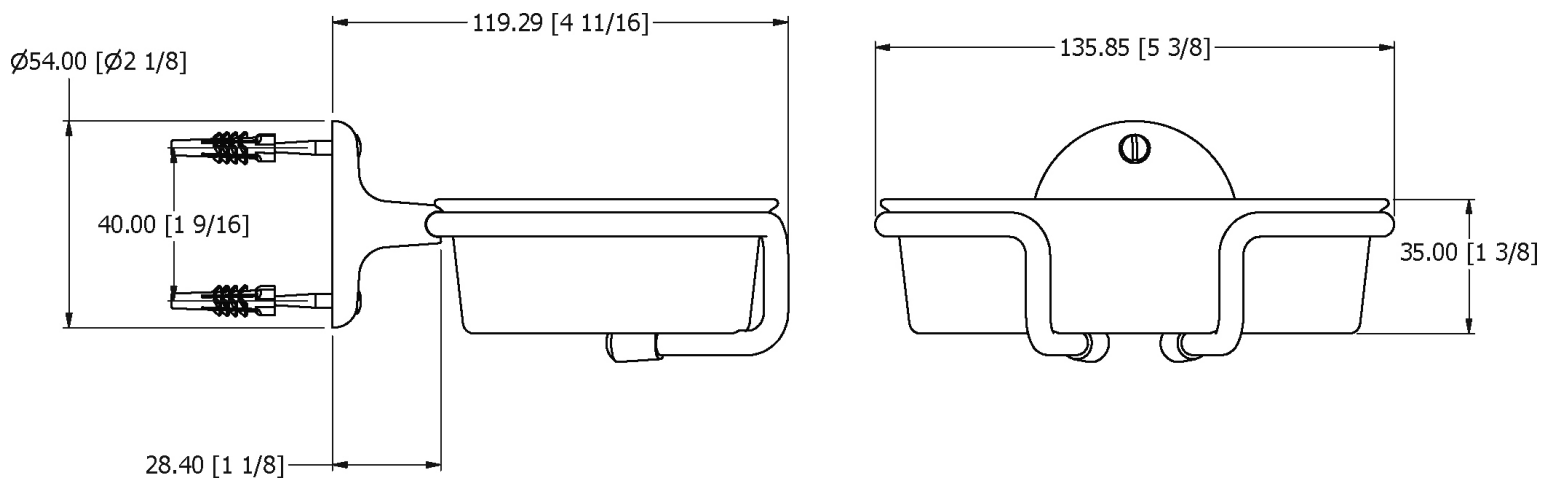

UK Customer Service

Leopold Street
Birmingham
B12 0UJ
Tel: +44 121 766 4200
Email: info@samuel-heath.com

US Customer Service

Federal I.D. No. 58-1504682
Email: usa@samuel-heath.com

Specification Enquiries

Design Centre Chelsea Harbour
1st Floor, North Dome, London
SW10 0XE
Tel: 020 7352 0249
Email: showroom@samuel-heath.com

1-06/12/2018