

artos[®]

M06875H

INSTALLATION GUIDE

denby towel warmer,
hydronic

BRUSHED NICKEL(BN)



OIL RUBBED BRONZE(OB)



CHROME(CH)



WHITE(WH)

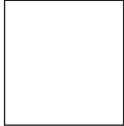

POLISHED NICKEL(PN)



BLACK(BK)



M06875H

denby towel warmer,
hydronic

OPERATING SPECIFICATIONS



FEATURES

Towel warming, drying and auxiliary heating.

HEAT OUTPUT

1720 BTU

CODES

UL Approved
CSA-US Approved

REQUIREMENTS

Towel warmers must be used in a closed water system, incorporating a rust inhibitor.

artos[®]

M06875H

PRODUCT DIMENSIONS

denby towel warmer,
hydronic

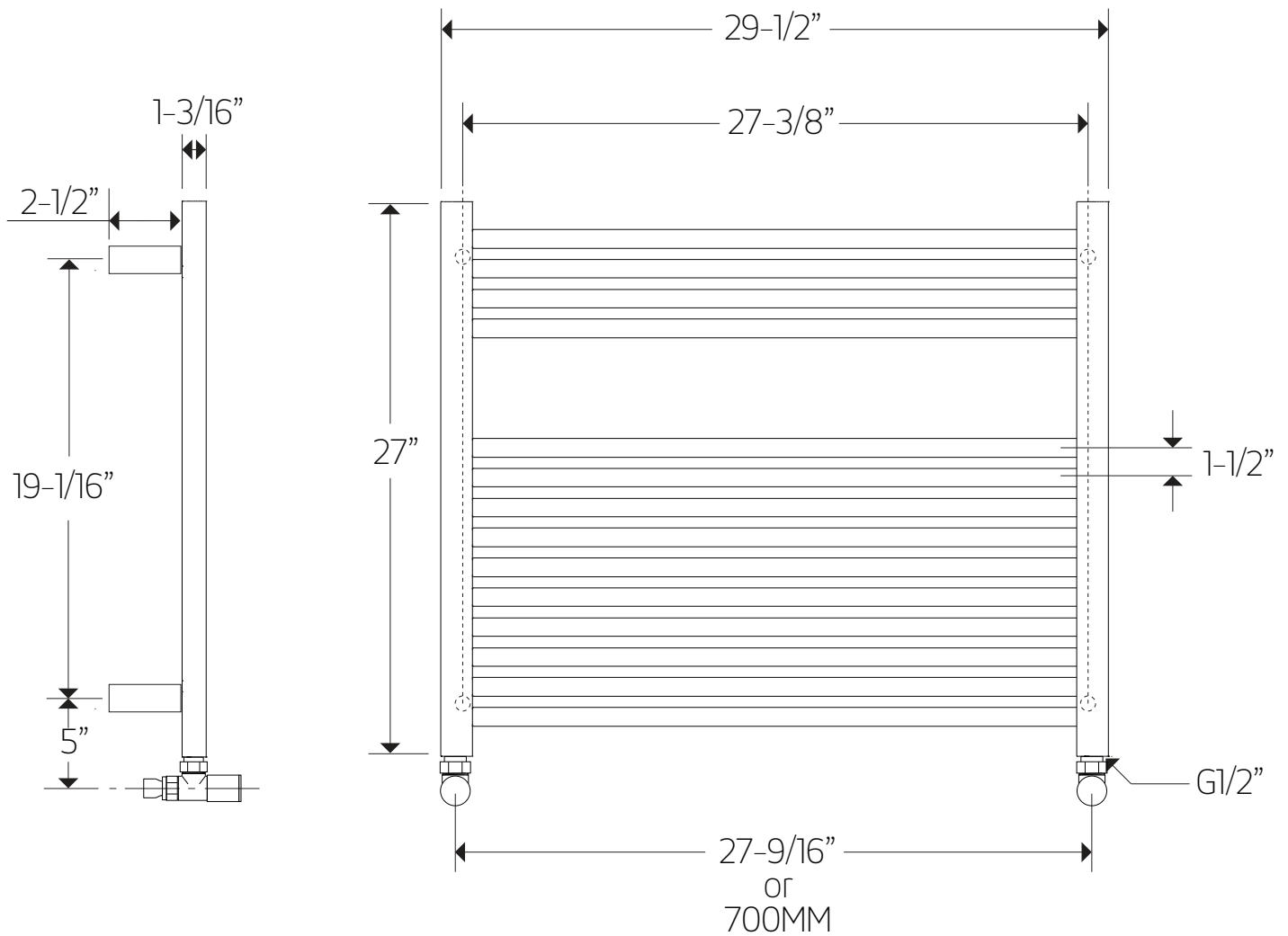

M06875H

denby towel warmer,
hydraulic

BRACKET & PIPE POSITION

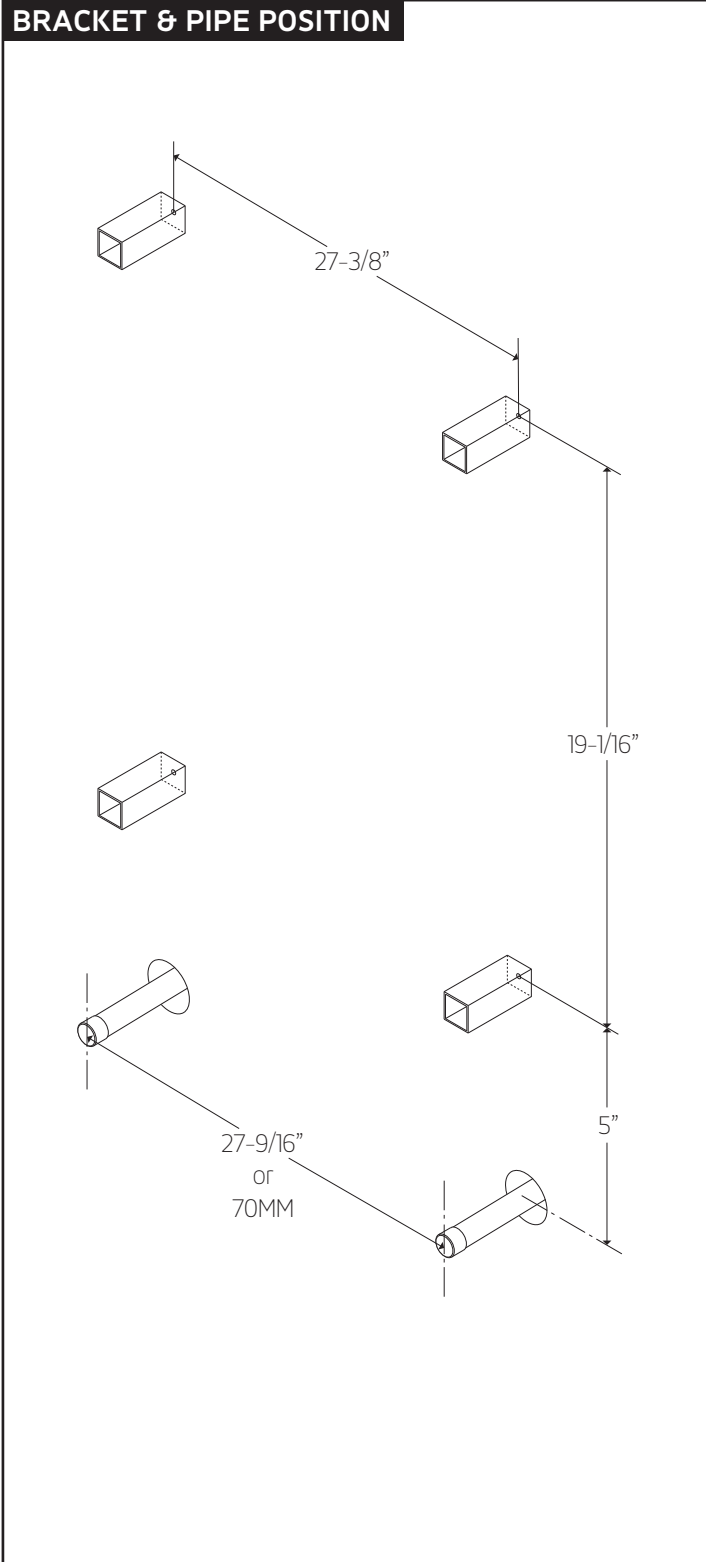

BRACKET & PIPE POSITION

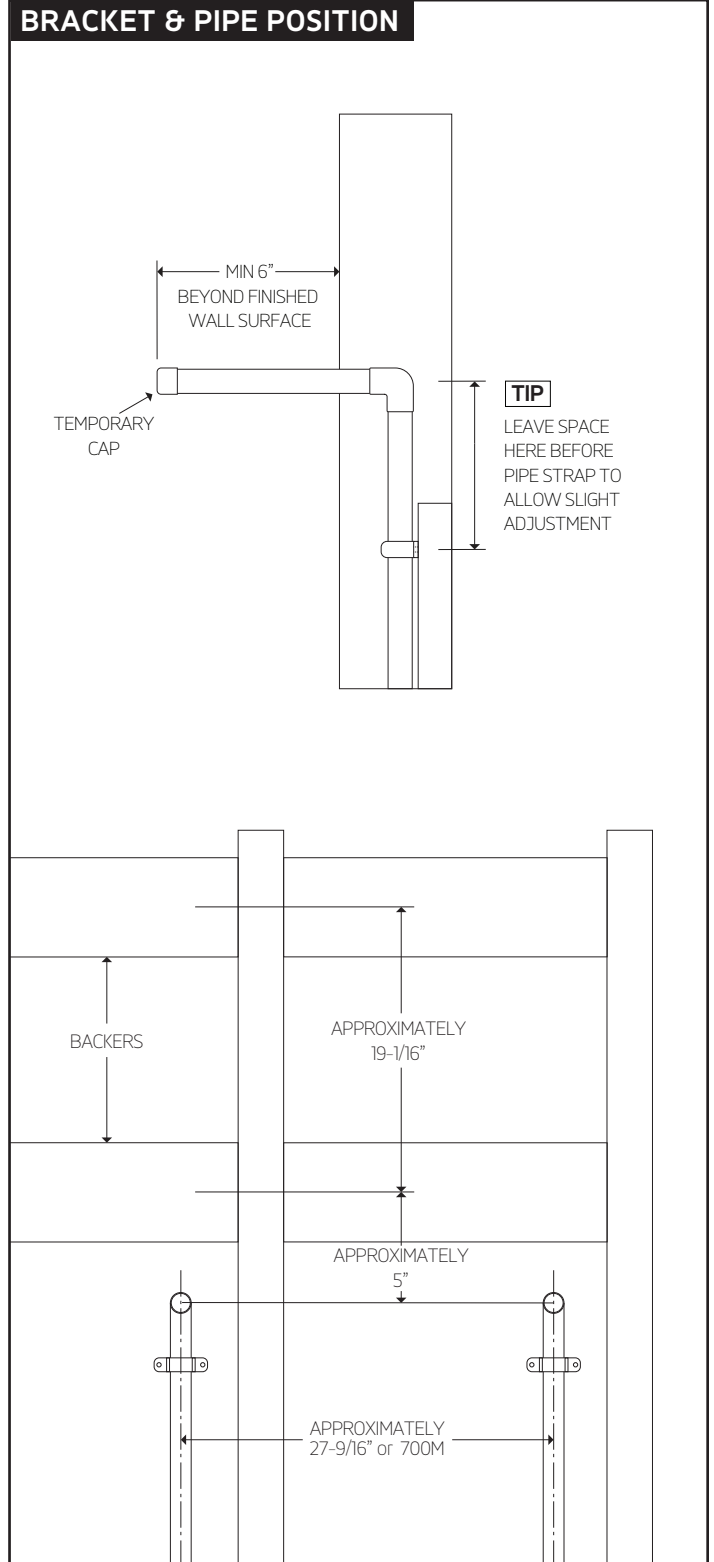

INSTALLATION STEPS

STEP 1

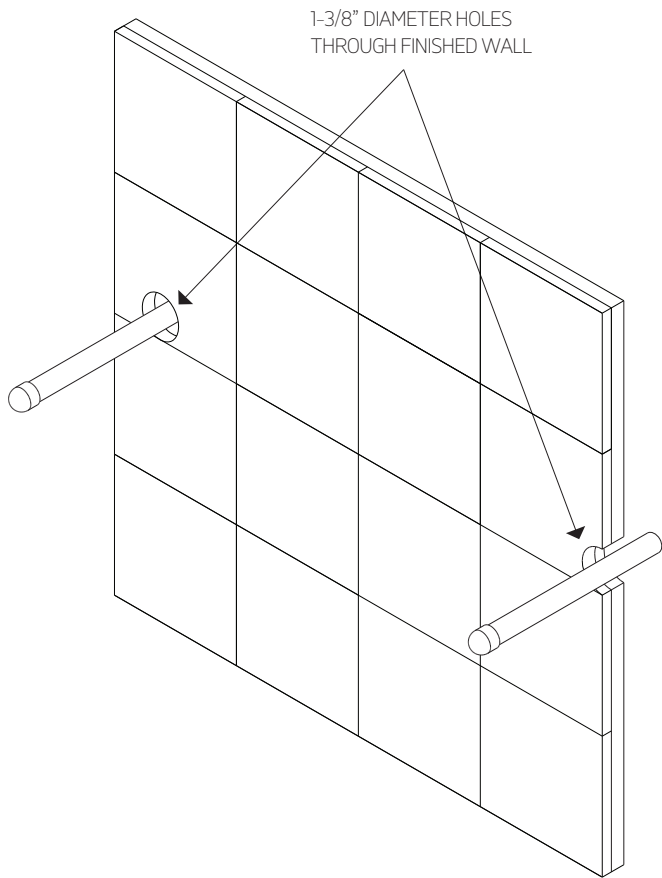

STEP 2

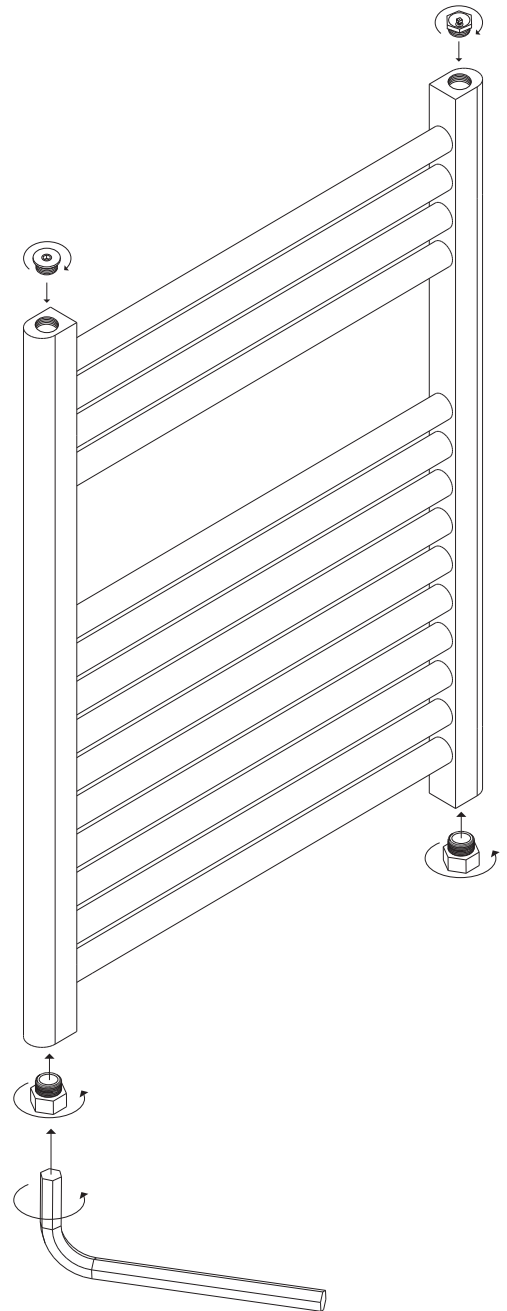

M06875H

denby towel warmer,
hydronic

STEP 3 INSTALL BRACKETS: MEASURE TOWEL WARMER FRAME FOR EXACT BRACKET SPACING BEFORE INSTALLATION

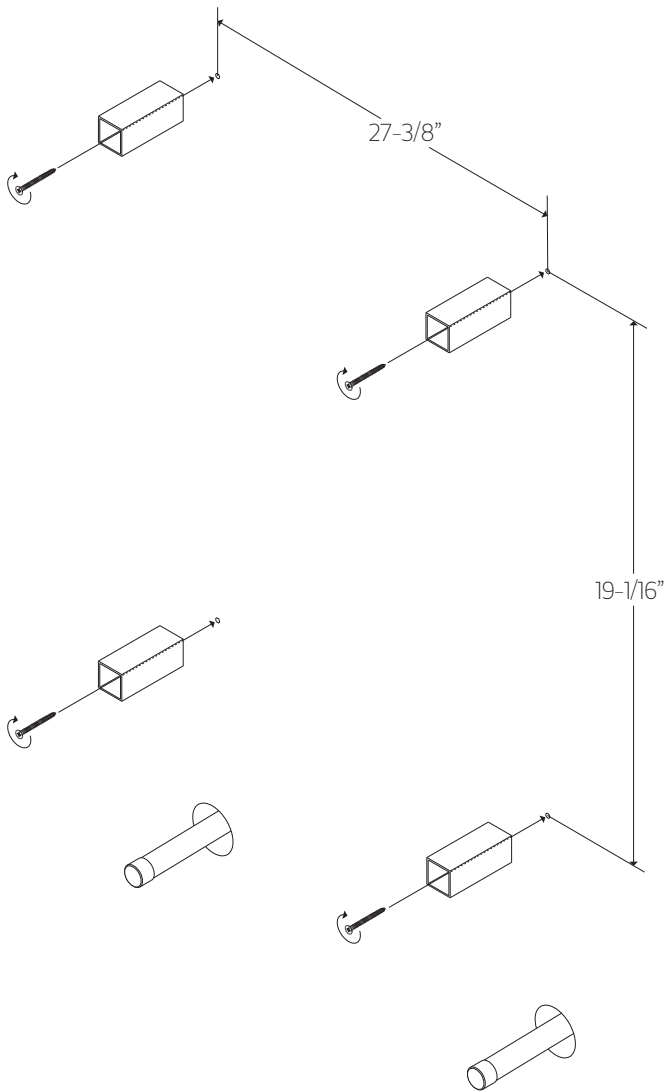

STEP 4

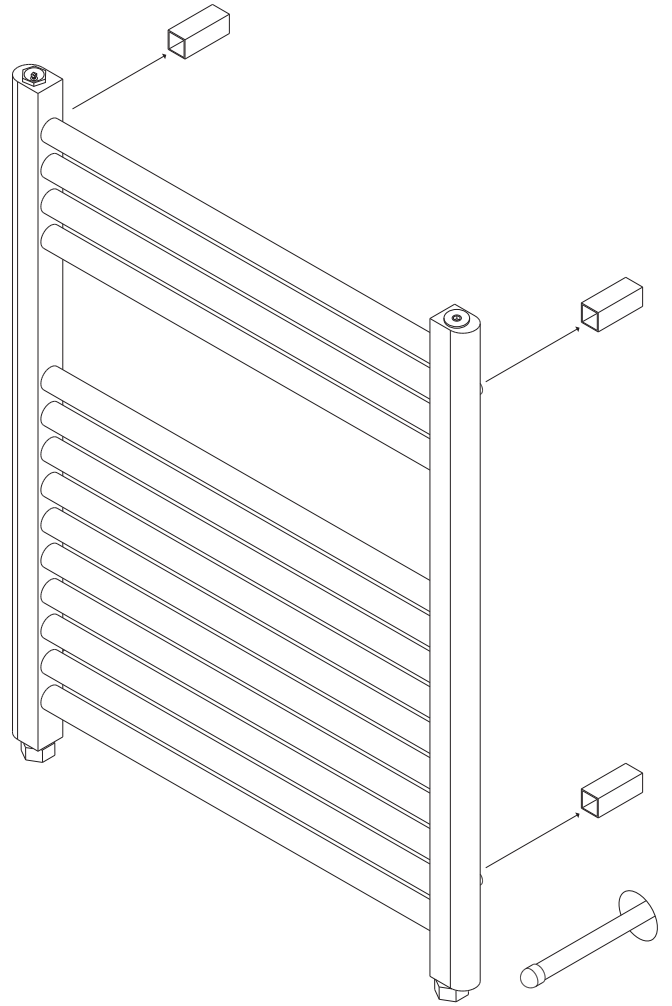

INSTALLATION STEPS

STEP 5

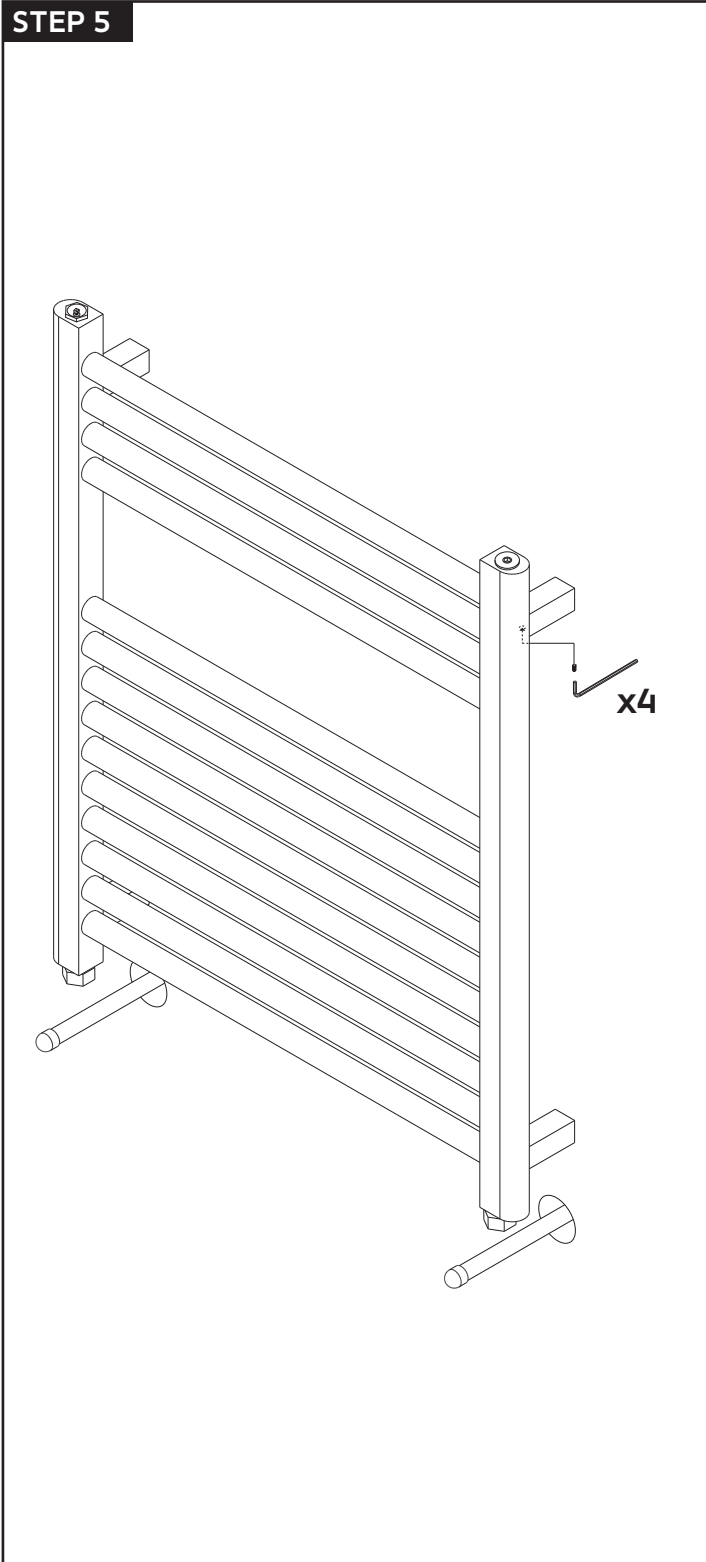

STEP 6

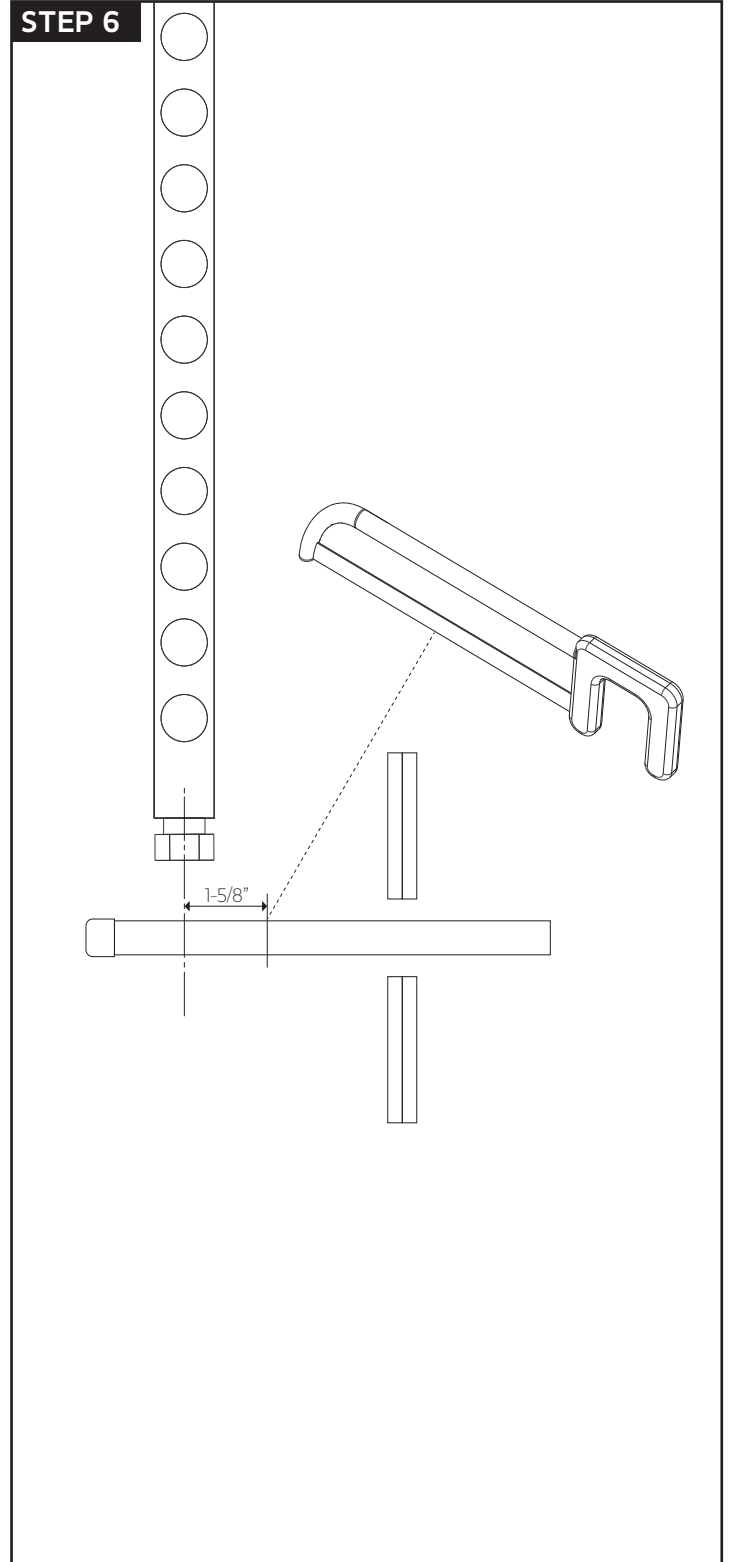

M06875H

denby towel warmer,
hydraulic

STEP 7 NOTE: IF NOT USING PIPE COVER SLEEVES- GO TO THE NEXT STEP

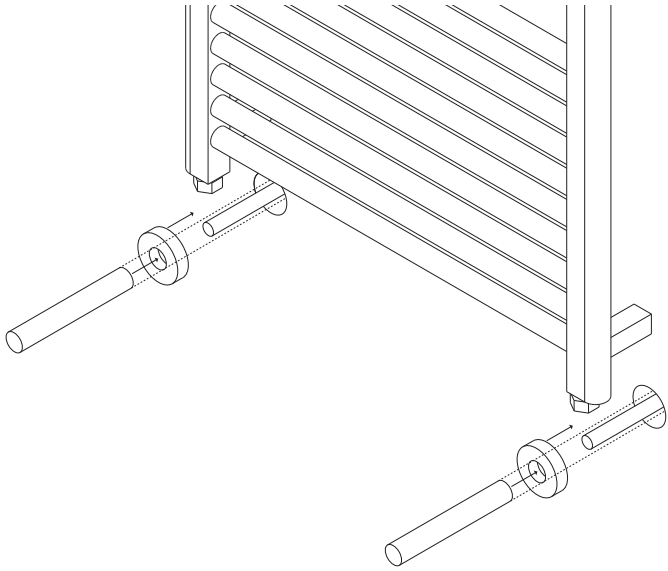

STEP 8

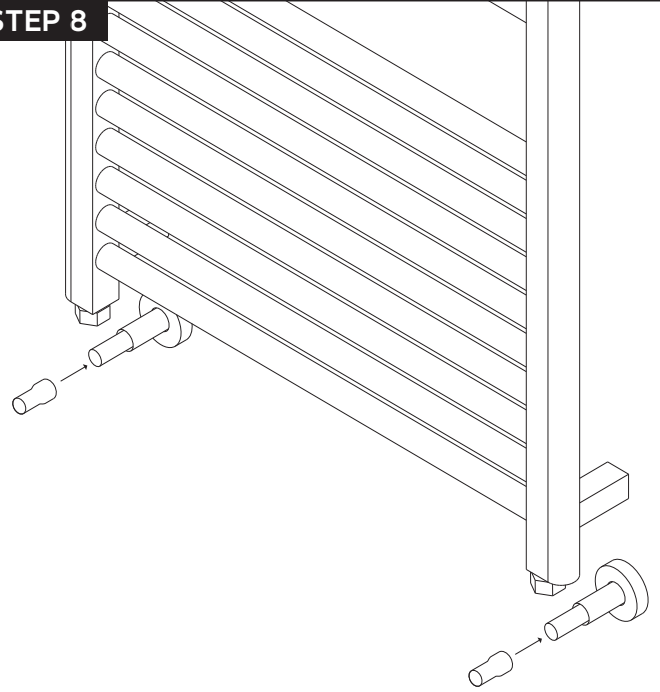

SOLDER COPPER ADAPTER

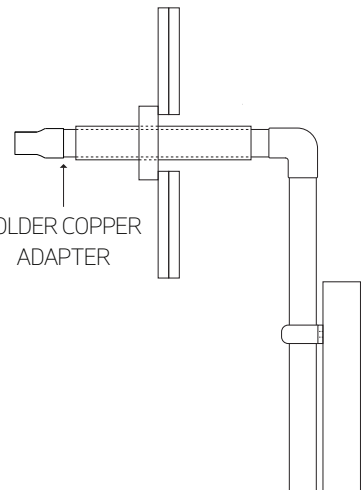

INSTALLATION STEPS

STEP 9

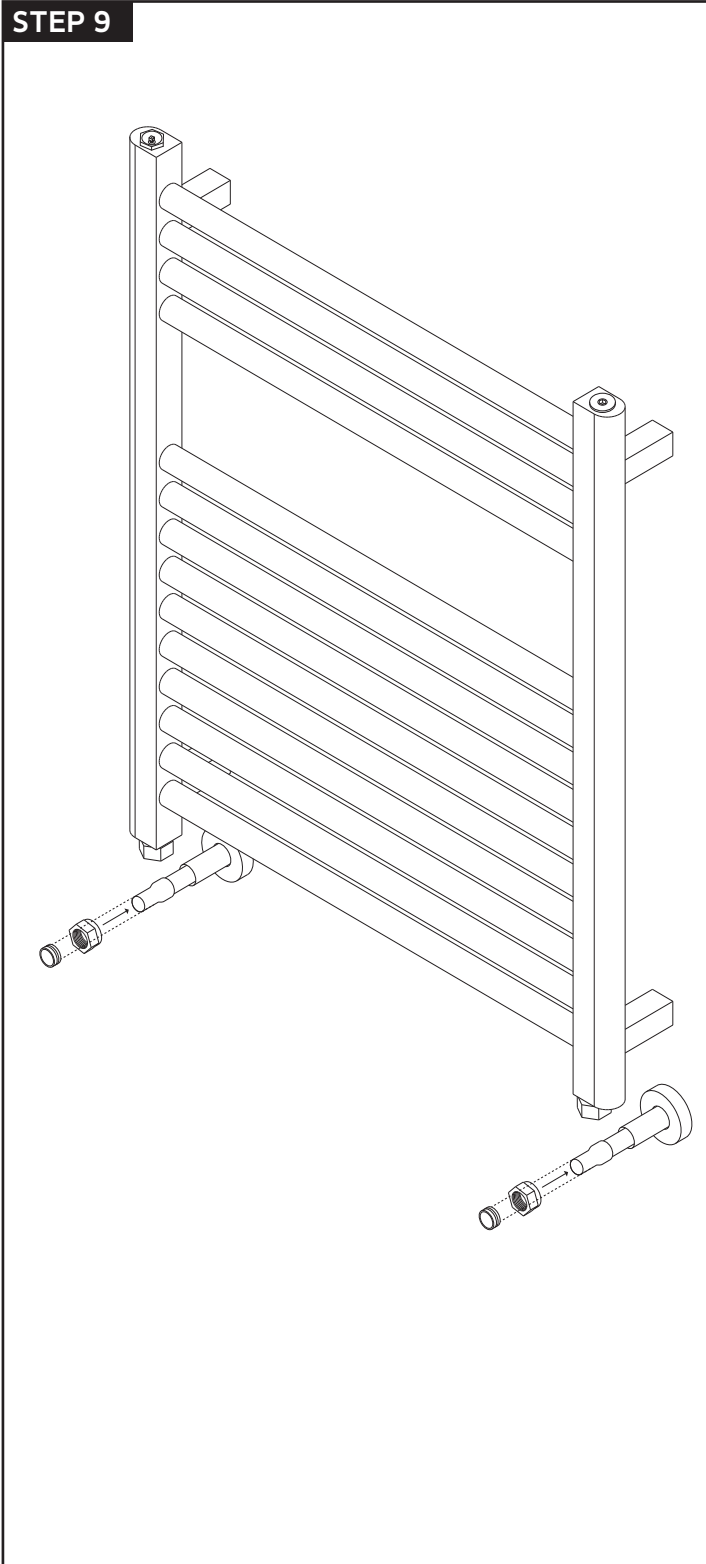

STEP 10

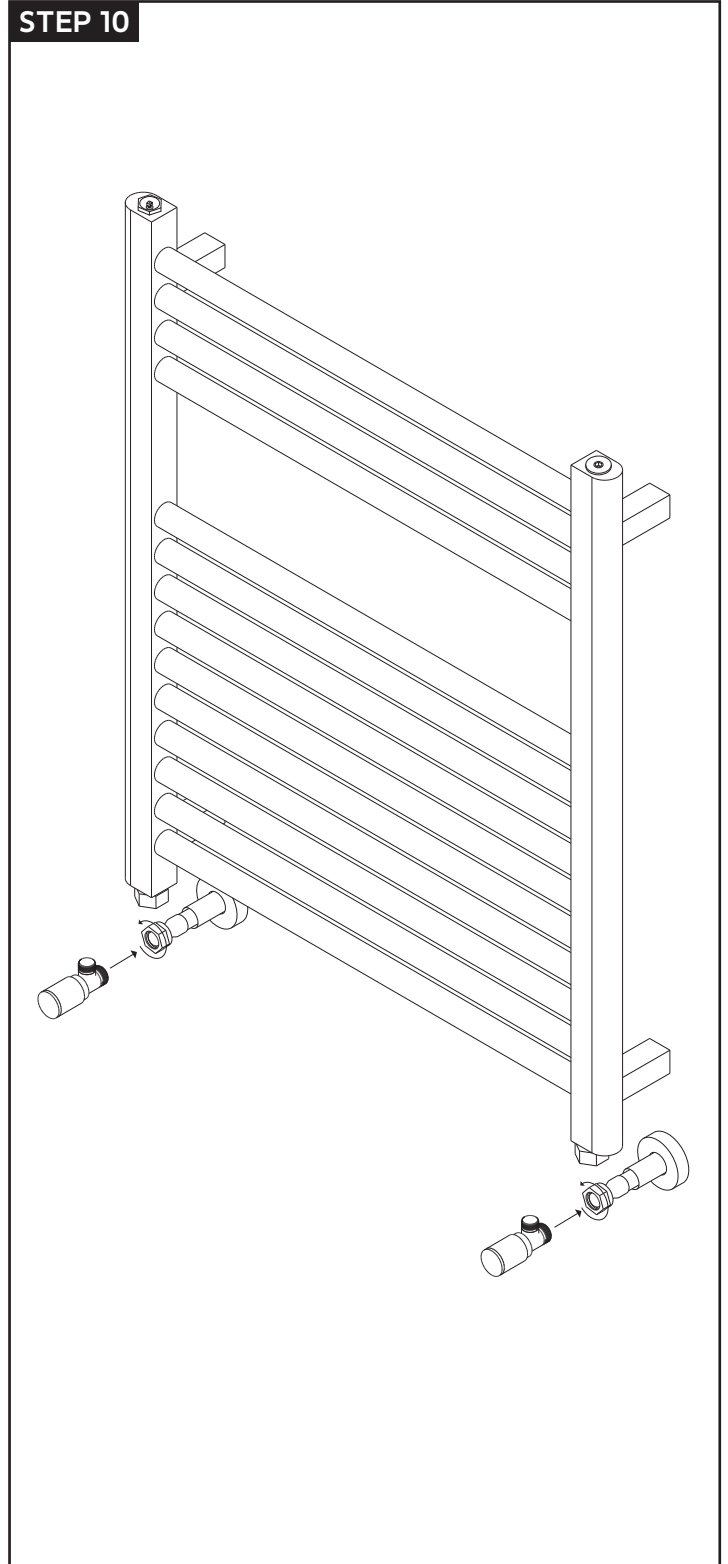

M06875H

denby towel warmer,
hydraulic

INSTALLATION STEPS

STEP 11

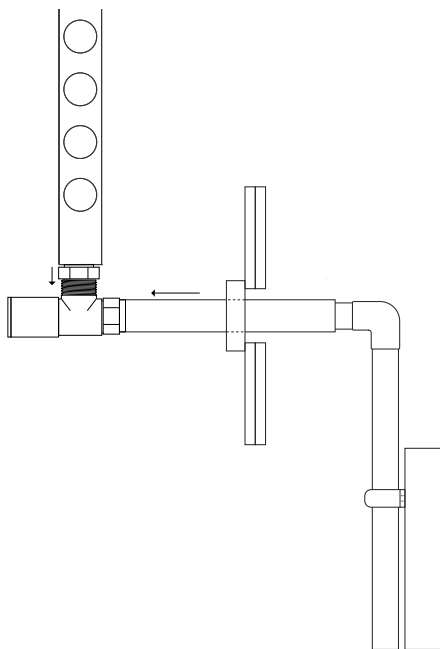
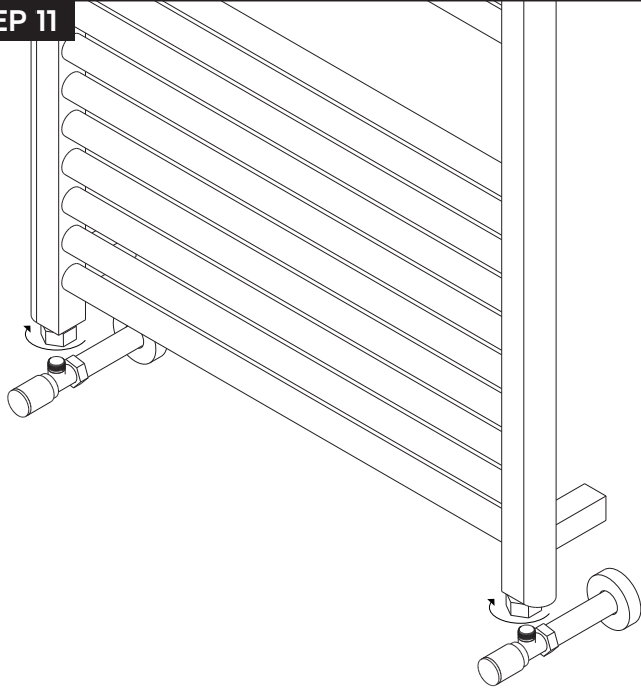

STEP 12 CAUTION HOT WATER

**BLEED TOWEL WARMER:
LOOSEN PRESSURE RELEASE SCREW, OPEN SUPPLY
AND RETURN VALVE, ALLOW WATER TO FILL THE
TOWEL WARMER, TIGHTEN PRESSURE RELEASE
SCREW WHEN WATER APPEARS**

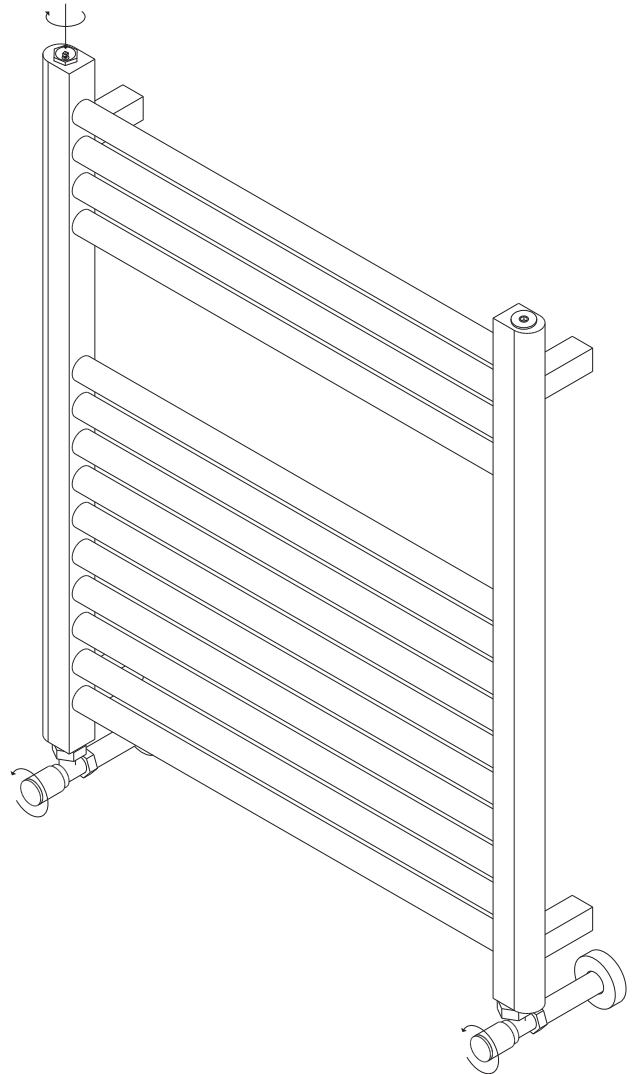

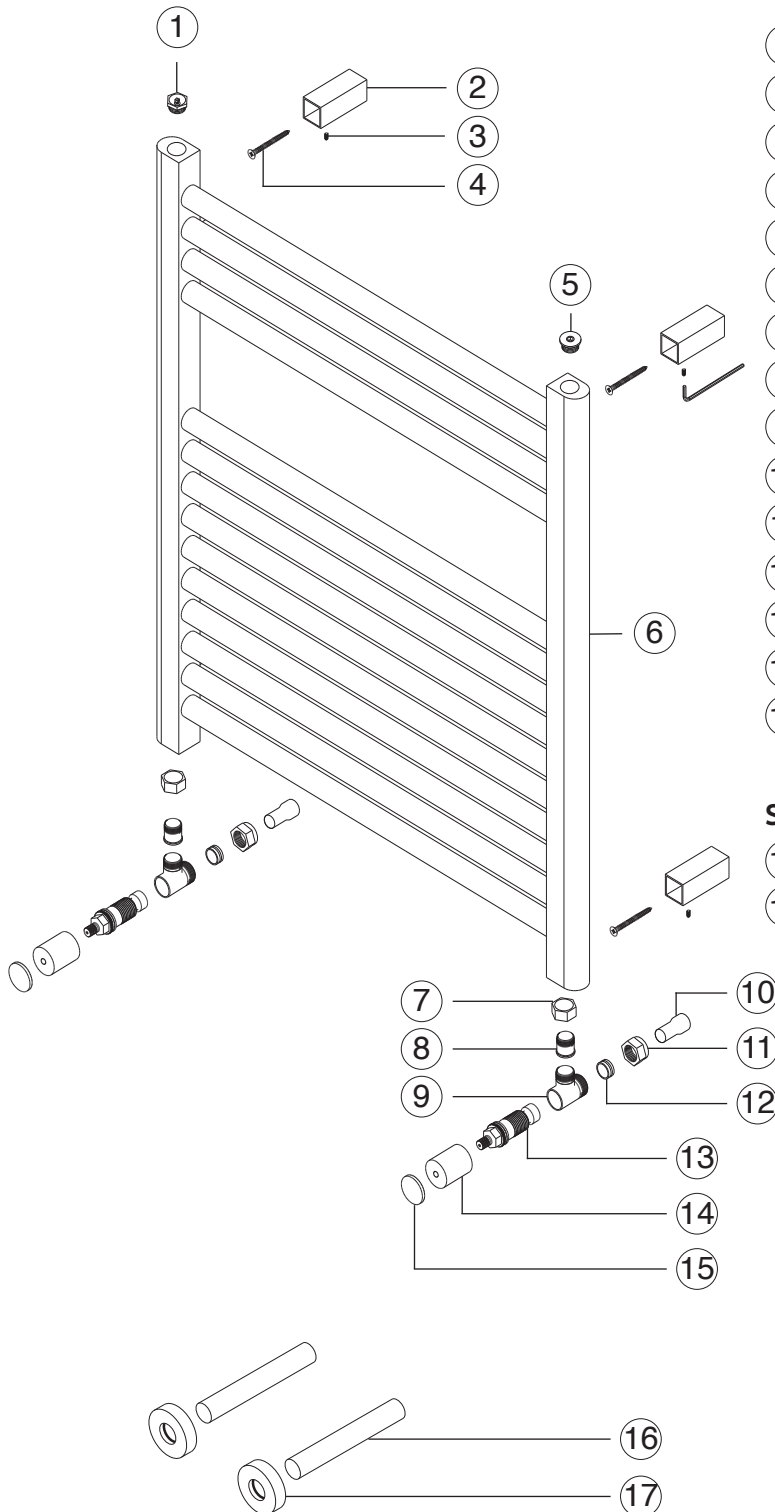

- ① **PRESSURE RELEASE CAP** M06875H XP1
- ② **BRACKET(4)** M06875H XP2
- ③ **BRACKET SET SCREW(4)** M06875H XP3
- ④ **BRACKET SCREW(4)** M06875H XP4
- ⑤ **BLANKING CAP** M06875H XP5
- ⑥ **TOWEL WARMER** M06875H X6
- ⑦ **VALVE NUT(2)** M06875H XP7
- ⑧ **MALE STEM (2)** M06875H XP8
- ⑨ **VALVE BODY (2)** M06875H XP9
- ⑩ **COPPER PIPE ADAPTOR (2)** M06875H XP10
- ⑪ **COPPER PIPE VALVE NUT (2)** M06875H XP11
- ⑫ **COMPRESSION RING (2)** M06875H XP12
- ⑬ **CARTRIDGE (2)** M06875H XP13
- ⑭ **VALVE HANDLE(2)** M06875H XP14
- ⑮ **HANDLE CAP (2)** M06875H XP15

SOLD SEPARATELY

- ⑯ **VALVE TAIL(2)** PX60 XP16
- ⑰ **ESCUTCHEON(2)** PX60 XP17

Artos® Warranty Decorative Towel Dryers

Artos® towel dryers have been manufactured under the highest quality and manufacturing standards.

Artos® towel dryers have a 5-year warranty against leaks and manufacturing defects to the finish. The heating element itself has a 2-year warranty.

For best results, keep the following in mind to retain the high quality finish of your Artos towel warmer:

- Use a soft, dampened sponge or cloth. On no account should you use a abrasive material such as a brush, scouring pad or steel wool to clean surfaces.
- Test your cleaning agent solution on an inconspicuous area before applying to the entire faucet.
- Wipe surfaces clean and rinse completely with water immediately after applying cleaning agent.
- An ideal cleaning technique is to rinse faucet thoroughly and blot dry an water from the surface after each use.

This warranty applies to installations in the US, Canada and Mexico (North America). Commercial, Industrial or business uses are warranted for a period of one year from the original date of purchase. This warranty is non-transferable and applies exclusively to the original owner or end-user.

If a defect is found during normal use, Artos® will, at its election, repair, replace or make an appropriate adjustment. Damage caused by accident, misuse, abuse, improper installation or alteration will void the warranty.

This warranty does not cover replacement parts where damage is caused by normal wear and tear. Labor charges, installation or other incidental or consequential costs will not be covered. Replacement parts that qualify for warranty repair can be obtained by contacting Artos® at 1-877-9ARTOS9 or by e-mail at info@artos.us.co

Proof of purchase (original sales receipt) from the original consumer purchaser must accompany all warranty claims. When submitting your claim in writing, please provide your name, address and telephone number.