

M06875P

INSTALLATION GUIDE

denby towel warmer,
plug-in

BRUSHED NICKEL(BN)



OIL RUBBED BRONZE(OB)

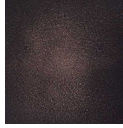

CHROME(CH)

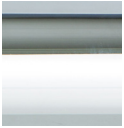

WHITE(WH)



POLISHED NICKEL(PN)



BLACK(BK)



artos[®]

M06875P

denby towel warmer,
plug-in

OPERATING SPECIFICATIONS



FEATURES

Towel warming, drying and auxiliary heating.

ELEMENT

300W, 110V

CODES

UL Approved
CSA-US Approved

REQUIREMENTS

The towel warmer must be installed so that the Element is at the bottom.

M06875P

PRODUCT DIMENSIONS

denby towel warmer,
plug-in

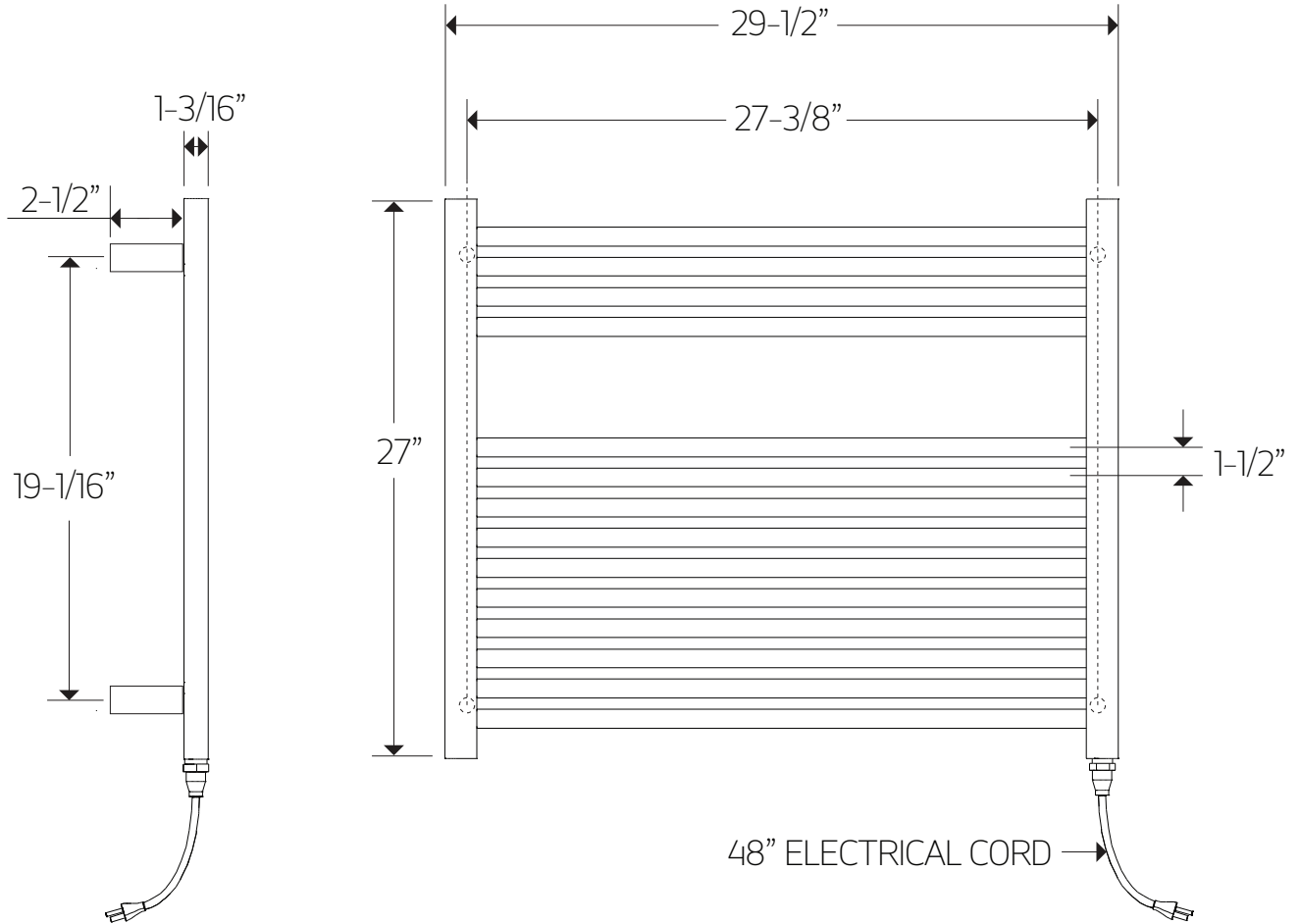

artos[®]

M06875P

denby towel warmer,
plug-in

STEP 1

*DIMENSIONS ARE APPROXIMATE FOR
BLOCKING PURPOSES, PLEASE MEASURE UNIT

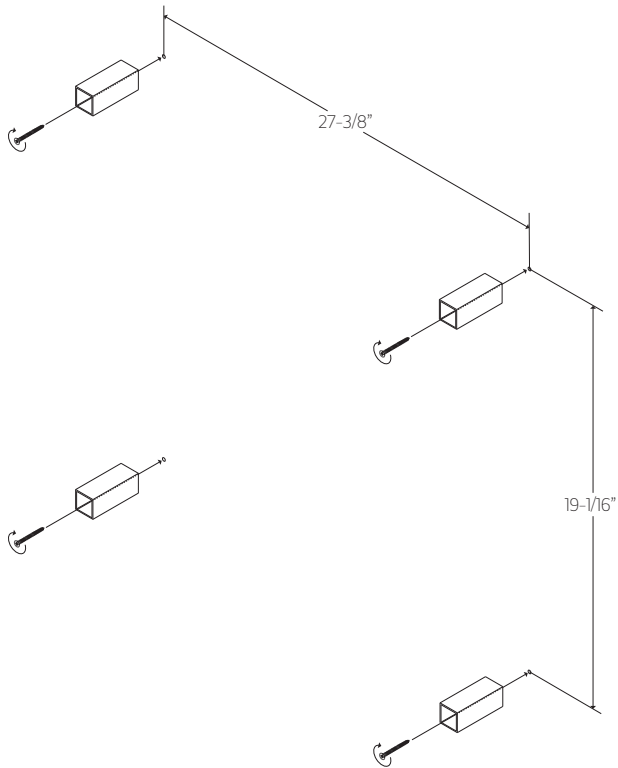

STEP 2

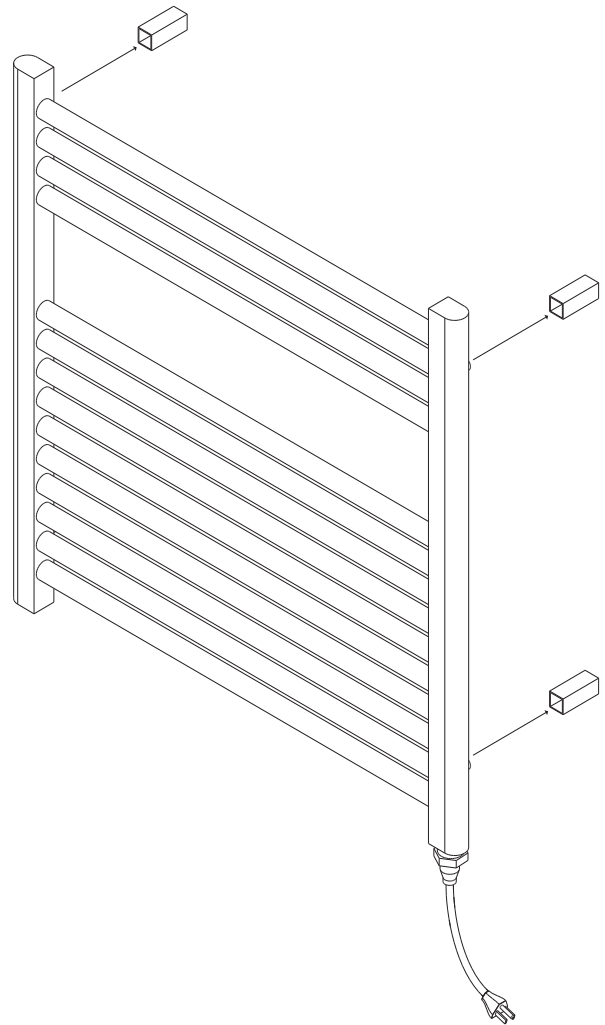

WE RECOMMEND THAT AT LEAST
2 OF THE WALL BRACKETS ARE
SECURED INTO A STUD OR BACKER

INSTALLATION STEPS

STEP 3

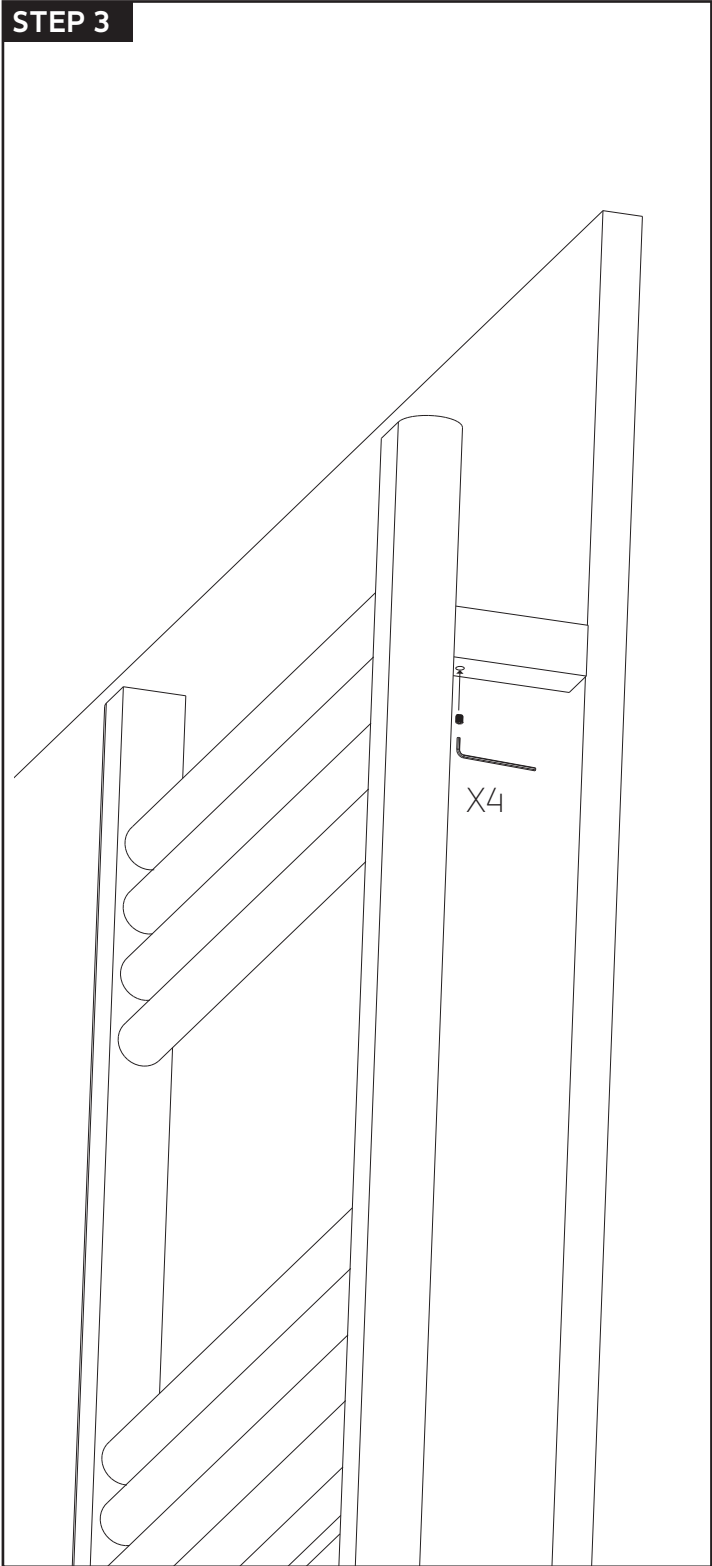

artos[®]

M06875P

denby towel warmer,
plug-in

PARTS BREAKDOWN

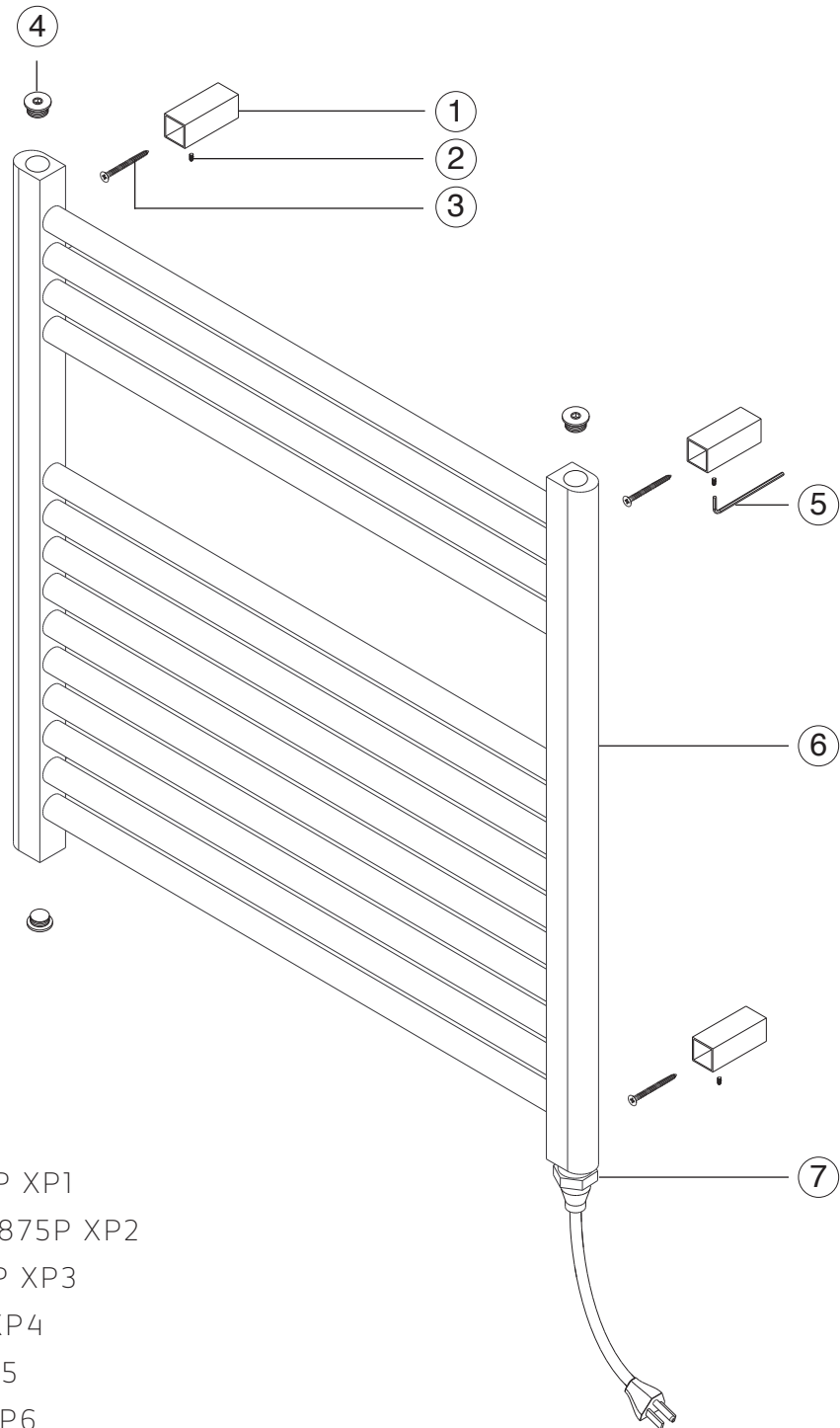

- ① WALL BRACKET(4) M068475P XP1
- ② BRACKET SET SCREW(4) M06875P XP2
- ③ BRACKET SCREW(4) M06875P XP3
- ④ BLANKING CAP(3) M06875P XP4
- ⑤ ALLEN WRENCH M06875P XP5
- ⑥ TOWEL WARMER M06875P XP6
- ⑦ ELEMENT M06875P XP7

Artos® Warranty Decorative Towel Dryers

Artos® towel dryers have been manufactured under the highest quality and manufacturing standards.

Artos® towel dryers have a 5-year warranty against leaks and manufacturing defects to the finish. The heating element itself has a 2-year warranty.

For best results, keep the following in mind to retain the high quality finish of your Artos towel warmer:

- Use a soft, dampened sponge or cloth. On no account should you use a abrasive material such as a brush, scouring pad or steel wool to clean surfaces.
- Test your cleaning agent solution on an inconspicuous area before applying to the entire faucet.
- Wipe surfaces clean and rinse completely with water immediately after applying cleaning agent.
- An ideal cleaning technique is to rinse faucet thoroughly and blot dry an water from the surface after each use.

This warranty applies to installations in the US, Canada and Mexico (North America). Commercial, Industrial or business uses are warranted for a period of one year from the original date of purchase. This warranty is non-transferable and applies exclusively to the original owner or end-user.

If a defect is found during normal use, Artos® will, at its election, repair, replace or make an appropriate adjustment. Damage caused by accident, misuse, abuse, improper installation or alteration will void the warranty.

This warranty does not cover replacement parts where damage is caused by normal wear and tear. Labor charges, installation or other incidental or consequential costs will not be covered. Replacement parts that qualify for warranty repair can be obtained by contacting Artos® at 1-877-9ARTOS9 or by e-mail at info@artos.us.co

Proof of purchase (original sales receipt) from the original consumer purchaser must accompany all warranty claims. When submitting your claim in writing, please provide your name, address and telephone number.