



TL4

Interior Tubular Latch For Swing Doors

HIGHLIGHTS

- Latch sets consist of beautifully designed trim made of stainless steel or forged brass, a spring-assisted interlocking chassis, and a commercial grade tubular latch for high-end residential, mixed use, and hotel or other hospitality openings
- Stainless steel latch stabilizer bracket designed to handle heavy torque on the 28 degree latch retraction
- Applicable with all INOX decorative levers, knob, and escutcheon designs with no special modification

SPECIFICATIONS

Latch Faceplate	1" x 2-1/4" square corner
Door Thickness	1-3/8"(35mm) to 1-3/4"(44mm) Thick door kits available
Backset	2-3/8" (60mm) 2-3/4" (70mm)
Lever Spindle	8 x 8mm square
Lever Action	28 degree
Handing	Latch is field reversible Specify for Half Passage or Passage with Privacy Bolt

APPLICATION

TL4 Tubular latches are suitable for a wide range of applications, including but not limited to: Hospitality, Mixed-use and high-end Residential.

CODE COMPLIANCE



- ANSI/BHMA A156.3 Grade 2
- Fire-rated latch tested for UL10B / UL10C to 3 hours
- UBC Standard 7-2 (1997) NFPA 252
- NFPA 80 National Fire Protection-Fire Door Assembly
- NFPA 101 National Fire Protection-Life Safety
- ANSI/BHMA A156.18 Finishes
- ANSI A117.1 ADA Accessibility for lever sets

DOOR PREPARATION

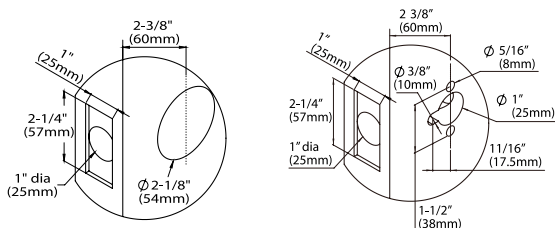

Standard RA/SE Prep

Standard GT/GS Prep

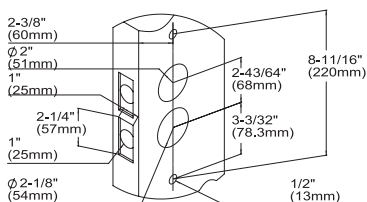

LA/SF Prep

HOW TO ORDER

Specify the Rose, Lever Design, Function, Backset, Finish and Handing using the product identification below:

Standard Product Identifications

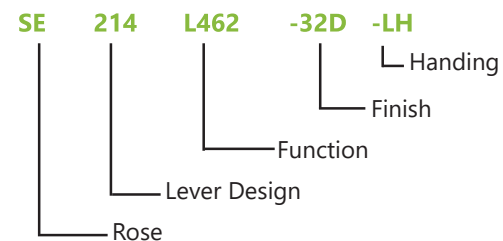

TL4 TUBULAR LATCH

FUNCTION

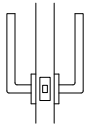

Passage

- Both levers are always unlocked

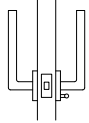

Privacy

- Push the privacy pin from inside to lock door
- Unlock by turning inside lever or using emergency release pinhole located on outside rose or plate cover

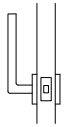

Half Passage

- Outside lever always unlocked; inside, dummy rose only
- Door cannot be opened from inside

CHANGE LATCH BOLT DIRECTION

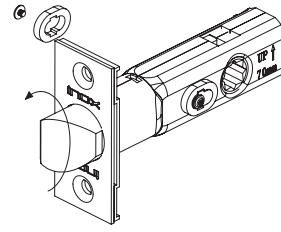

- Determine door handing for latch
- Remove INSIDE washer (privacy pin side)
- Rotate latch direction 180° with faceplate together
- Install latch with faceplate to the latch body

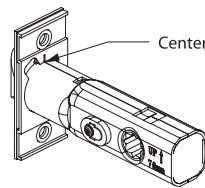

Center Line

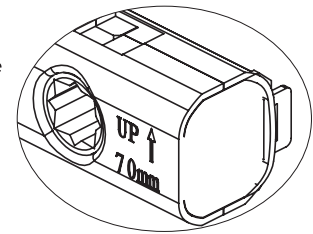

- Ensure that the center line on back of faceplate meets center seam of latch case
- Make sure the latch has the Arrow facing up

FUNCTION TABLE

	Passage	Privacy	Half Passage	Dummy
2-3/4" backset code	L471	L472	L475	PPD-RSL7
2-3/8" backset code	L461	L462	L465	PPD-RSL6
Latch	×	×	×	
Levers	×	×	×	×

STRIKES

All latches come with both T-Strike and Full-lip Strike with square corners. Full-lip Strike with Radius Corner and ASA Strike can be ordered separately.

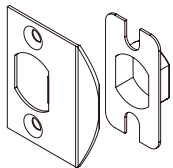

Full-lip Strike
LSR-D1
1-3/4" x 2-1/4"

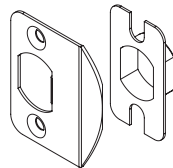

Full-lip Strike 1/4" Corner
LSR-D14
1-3/4" x 2-1/4"

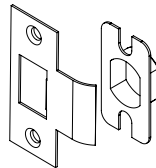

T-Strike
LSR-T1
1-1/8" x 2-3/4"

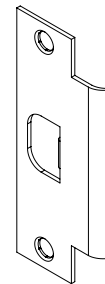

ADA Strike (ANSI Standard)
LSR-ADA
1-1/4" x 4-7/8"

TL4 TUBULAR LATCH

COMPONENTS

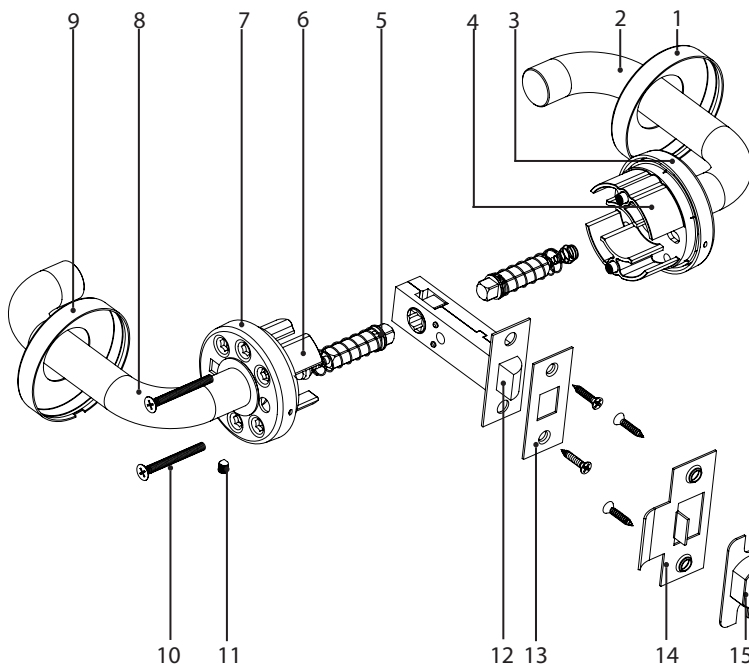

1. Outside Rose
2. Outside Lever
3. Sub-rose
4. Stabilizing Bracket
5. Spindle
6. Interior Bracket
7. Sub-rose
8. Inside Lever
9. Inside Rose
10. Thru-Bolts
11. Set Screw for Lever
12. Tubular Latch
13. Tubular Latch Faceplate
14. Tubular Latch Strike
15. Tubular Latch Dust Box

FINISH

Standard:

- 32 Bright Stainless Steel
- 32D Satin Stainless Steel
- 19G Graphite Black
- 10B Oil Rubbed Bronze
- PVD4 Satin Brass PVD

Special Order:

- CeraMax Ceramic Coating
 - C19G Ceramic Graphite Black
 - C19 Ceramic Flat Black
 - CGY Ceramic Stormy Grey
 - CDB Ceramic Dark Bronze

MATERIAL

Stainless Steel Face and Strike

ROSE AND ESCUTCHEONS



RA Rose



GT Rose



SE Rose



GS Rose



LA Plate



SF Plate



SH Plate

TL4 TUBULAR LATCH

LEVER DESIGN



101 Cologne
(32, 32D)



103 Oslo
(32, 32D)



104 Brussels
(32, 32D)



105 Frankfurt
(32, 32D, 10B, 19G)



106 Copenhagen
(32, 32D, 10B)



107 Stockholm
(32, 32D)



108 Vienna
(SP, PVD4)



210 Air-stream
(32, 32D, 10B)



211 Breeze
(32, 32D, 10B)



213 Cabernet
(32, 32D)



214 Champagne
(32, 32D, 10B)



217 Horizon
(32, 32D)



221 Aurora
(32, 32D, 10B, 19G)



223 Phoenix
(32, 32D)



225 Waterfall
(32, 32D)



226 Summer
(32, 32D)



227 Stratus
(32, 32D)



243 Sunrise
(32, 32D, 10B, 19G, PVD4)



251 Sequoia
(32, 32D, SP)



311 Crest
(32, 32D, 10B)



318 Café
(32, 32D, 19G)



344 Ecco
(32, 32D)



345 Tokyo
(32, 32D, 19G)



351 Toronto
(32, 32D)



379 Arctic
(32, 32D)



380 Polaris
(32, 32D, 10B)

Lever Designs with "Return To Door" (RTD)*

*Compliant with fire code



102 Munich
(32, 32D)



109 Stuttgart
(32, 32D)



244 Twilight
(32, 32D)



346 Osaka
(32, 32D)