

## Flush Cup Pocket Pulls (Dummy/Passage Only)

### Specifications

Stainless Steel, Concealed Fixing, Screws included Only available for Dummy/Passage Functions  
 Finishes: US32, US32D, US4, and (\*where noted) US10B  
 Ceramic Coating: Inquire about Lead Time

**FHIX01\***  
Flush Cup Pull

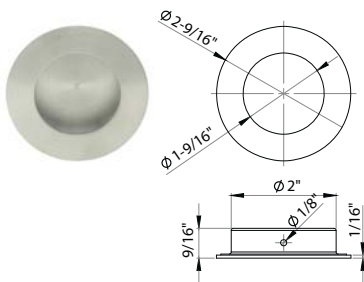

**FHIX02**  
Flush Cup Pull

2-3/4" prep required; will not work with standard 2-1/8" prep

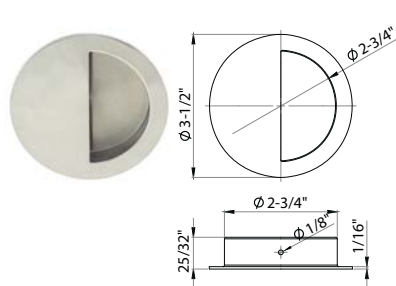

**FHIX03**  
Flush Cup Pull

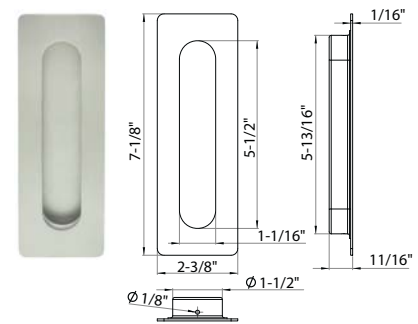

**FHIX04**  
Flush Cup Pull

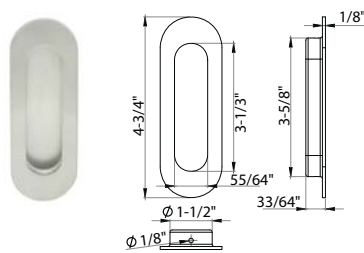

**FHIX05\***  
Flush Cup Pull

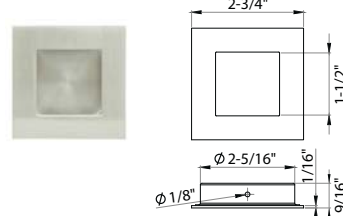

**FHIX06\***  
Flush Cup Pull

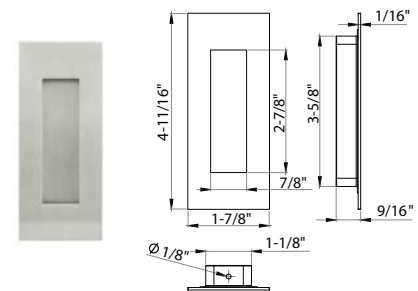

**FHIX07**  
Flush Cup Pull

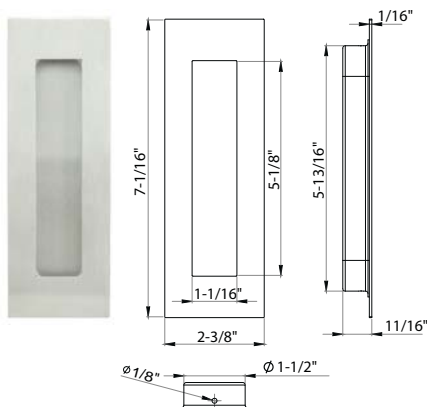

**EPIX01\***  
Edge Pull

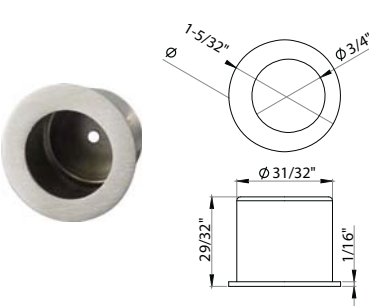

\*Also available in Oil Rubbed Bronze (US10B/613)