

Interchangeable Core

Best Compatible (Small Format)

► 725MD Mortise Deadbolt



For BEST style interchangeable core cylinders

Mortise Mounted



725MD
725MD-DW-VH



725MD-DR-LH



725MD-DW-IH



725MD-DR-RH

SPECIFICATIONS

Retrofits: Best 5L7MD

Mounting: Mortise

ANSI/BHMA: Passed ANSI/BHMA A156.11 Grade 1 performance requirements

Material: Zinc die cast cylinder housing, steel back plate and steel case

Cylinder length: 1-1/16" or 1-3/8"

Barrel diameter: 1-1/8"

Key-retaining: Available for DW-VH applications

Finish: US26, 26D, US3, US4 or 10B (1-3/8" barrel length locks available in 26D finish only)

Packaged: Packed 10 per box

KEYING INFORMATION

Cores: Not included

Accepts: Best, Arrow, Falcon, KSP, Schlage SFIC or equivalent small format interchangeable cores

Compatible electronic cylinders: Medeco Nexgen XT or VIDEX CyberLock SFIC cylinders

INCLUDED ACCESSORIES

725-1 spacer to fit 6 or 7 pin cores

725-SP-MD slotted rectangular strike

725-PA plastic thumbturn

OPTIONAL ACCESSORIES

See the accessories section of this catalog for a complete list.

Spacers: WP725 (1/8" thick), WP726 (1/4" thick)

Strikes: 725-SP Series

SFIC cores: 206/207 Series (page 60)

Item	Function	Finish	Cyl. Length	Description	
725MD-DR-RH	RH Door	26D, US26, US3, US4, 10B	1-1/16"	Lock body - For small format IC	
725MD3DR-RH	RH Door	26D	1-3/8"		
725MD-DR-LH	LH Door	26D, US26, US3, US4, 10B	1-1/16"		
725MD3DR-LH	LH Door	26D	1-3/8"		
725MD-DW-VH	VH Drawer	26D, US26, US3, US4, 10B	1-1/16"		
725MD3DW-VH	VH Drawer	26D	1-3/8"		
725MD-DW-IH	IH Drawer	26D, US26, US3, US4, 10B	1-1/16"		
725MD3DW-IH	IH Drawer	26D	1-3/8"		
Below locks are "key-retaining" (key removable in locked position only)					
725MD-DWKVH	VH Drawer	26D, US26, US3, US4, 10B	1-1/16"		Lock body - For small format IC
725MD3DWKVH	VH Drawer	26D	1-3/8"		

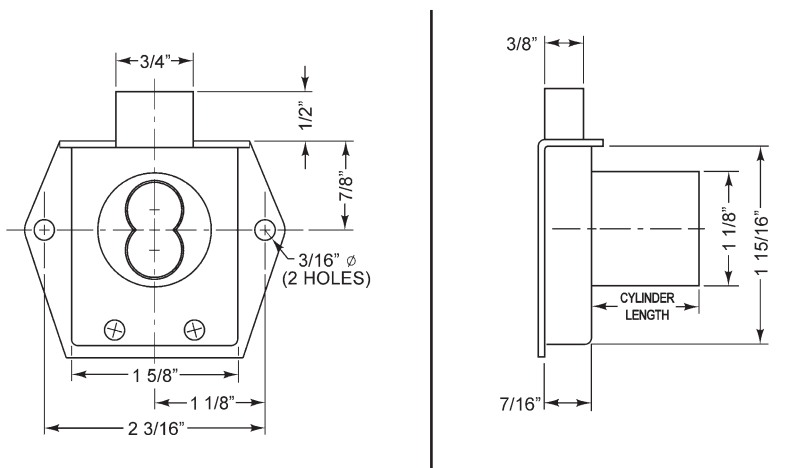

725MD

(Mortise Deadbolt) Standard configuration.
Dimensions are the same for all handings.



The following warning is applicable to all parts listed on this page:
WARNING: This product can expose you to chemicals including chromium, which is known to the State of California to cause cancer and birth defects or other reproductive harm. for more information go to www.P65Warnings.ca.gov.

