

YA93LM/DM

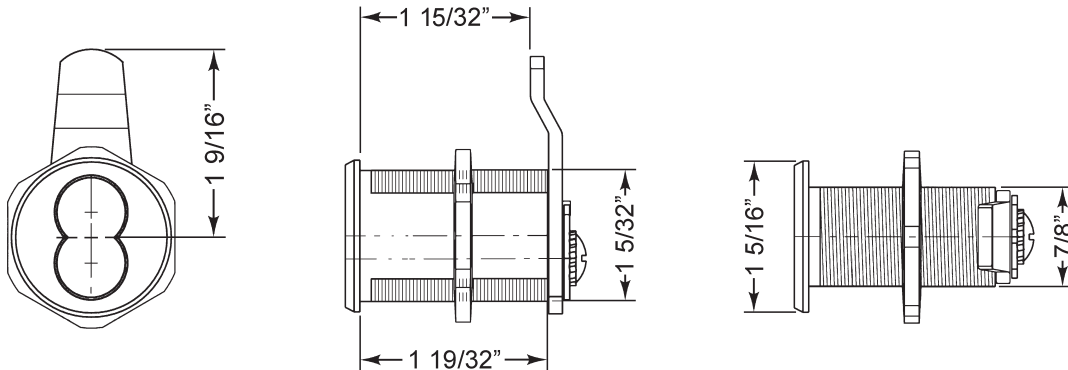

IMPORTANT:

It is highly recommended that you install the **cam/prong driver** and **lock cylinder** into the lock body and cycle to the locked position **before** assembling cam, cam shifter and stop pin onto the back of the lock.

Typical Installation

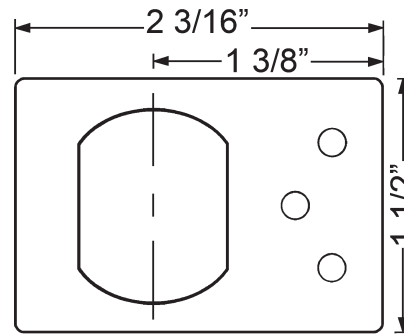
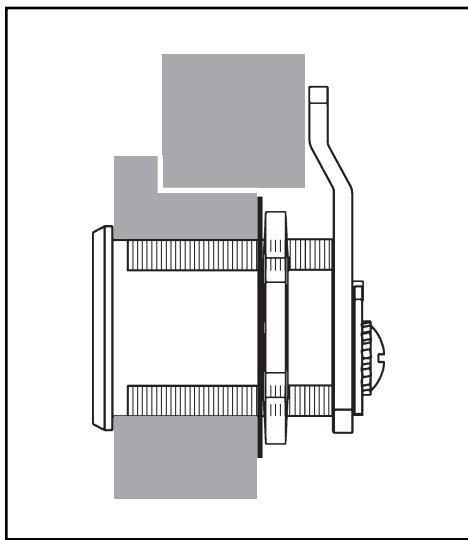

Stabilizer Plate

Mounting cutout

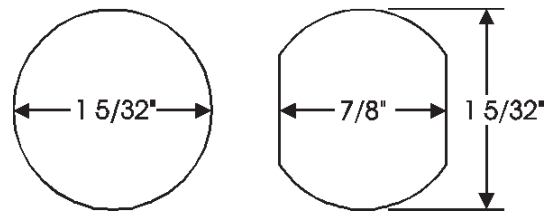



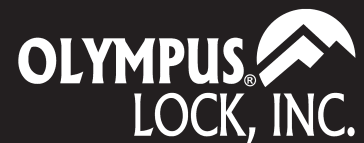

Lock diameter is 1-1/8". Drilled hole should be slightly larger.

Title Installation instructions for YA93LM/DM series cam lock				
Series YA93	Barrel Length 1-19/32"	Bolt type Cam lock	Mounting Surface	Revision Date 09/2014



YA93LM/DM

Assembled with vertical long cam 720-3-2 or
extra long 3" cam 720-3-4



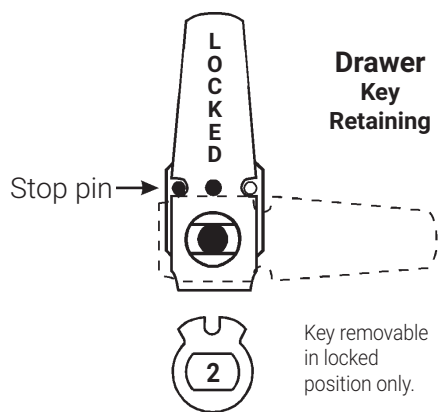
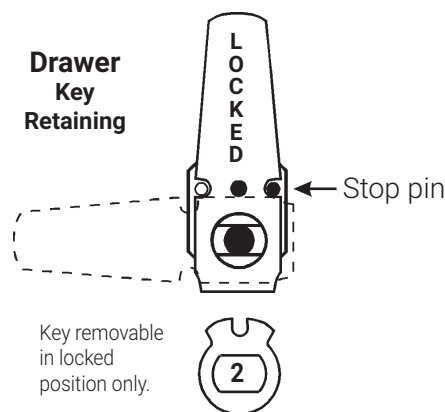
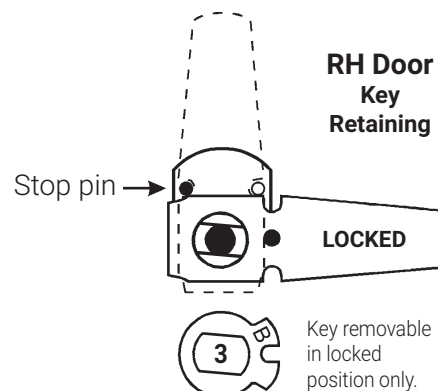
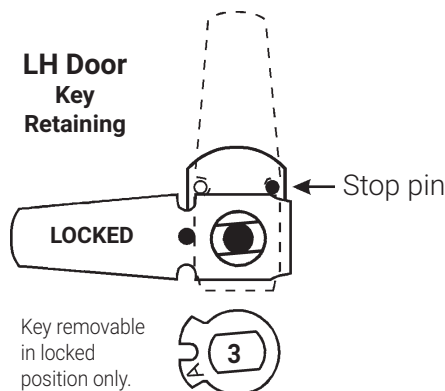
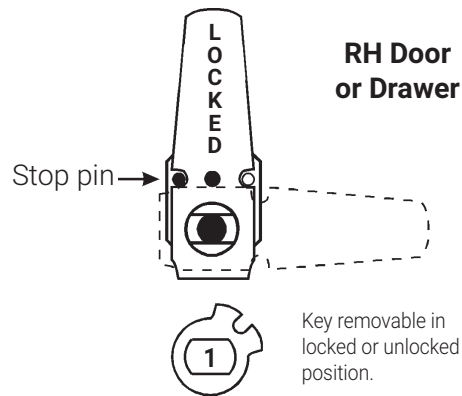
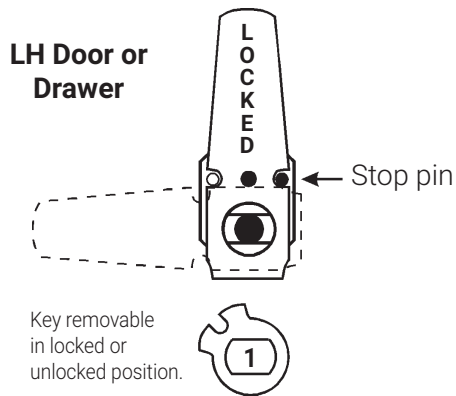

 1 720-CDLM lost motion cam shifter (non-key-retaining)	 2 720-KR key retaining drawer cam shifter	 3 720-CDDM (A Side) key retaining door cam shifter	 3 720-CDDM (B Side) key retaining door cam shifter
--------------------------------------------------------------------------------------------------------------------------------------------------------------------	-------------------------------------------------------------------------------------------------------------------------------------------------------	----------------------------------------------------------------------------------------------------------------------------------------------------------------	----------------------------------------------------------------------------------------------------------------------------------------------------------------

IMPORTANT! If your cam has a brass pin between the two notched cut outs use these instructions, otherwise see page 3.



YA93LM/DM

Assembled with vertical long cam 720-3-2 or
extra long 3" cam 720-3-4

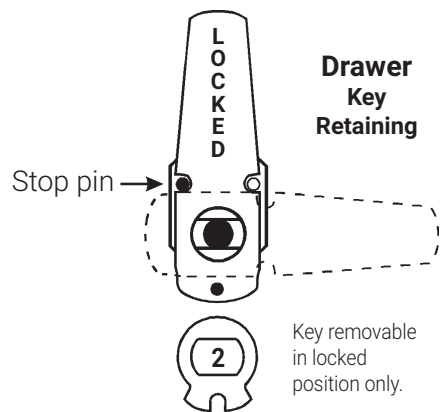
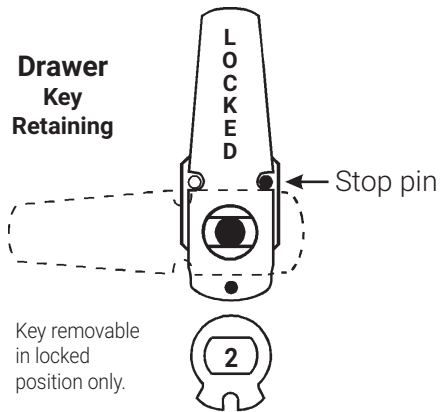
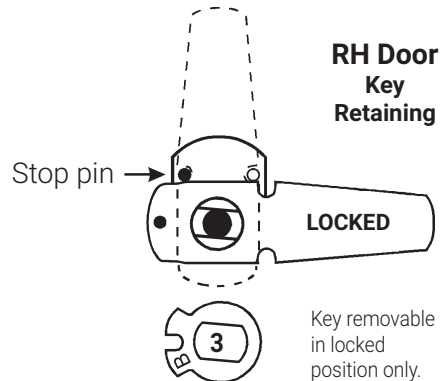
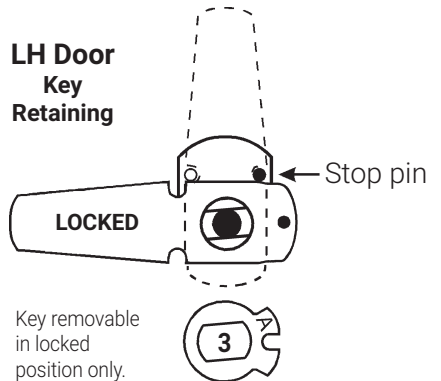
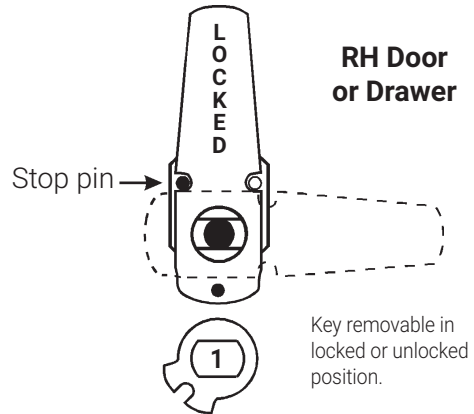
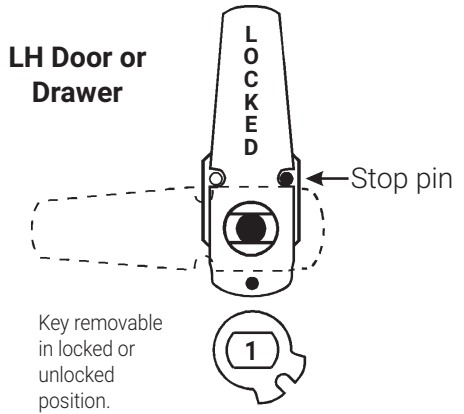

 <p>1 720-CDLM lost motion cam shifter (non-key-retaining)</p>	 <p>2 720-KR key retaining drawer cam shifter</p>	 <p>3 720-CDDM (A Side) key retaining door cam shifter</p>	 <p>3 720-CDDM (B Side) key retaining door cam shifter</p>
--------------------------------------------------------------------------------------------------------------------------------------------------------------------	-------------------------------------------------------------------------------------------------------------------------------------------------------	----------------------------------------------------------------------------------------------------------------------------------------------------------------	----------------------------------------------------------------------------------------------------------------------------------------------------------------

IMPORTANT! If your cam has a brass pin on the bottom of the cam use these instructions, otherwise see page 2.





YA93LM/DM

Assembled with short cam 720-3-1

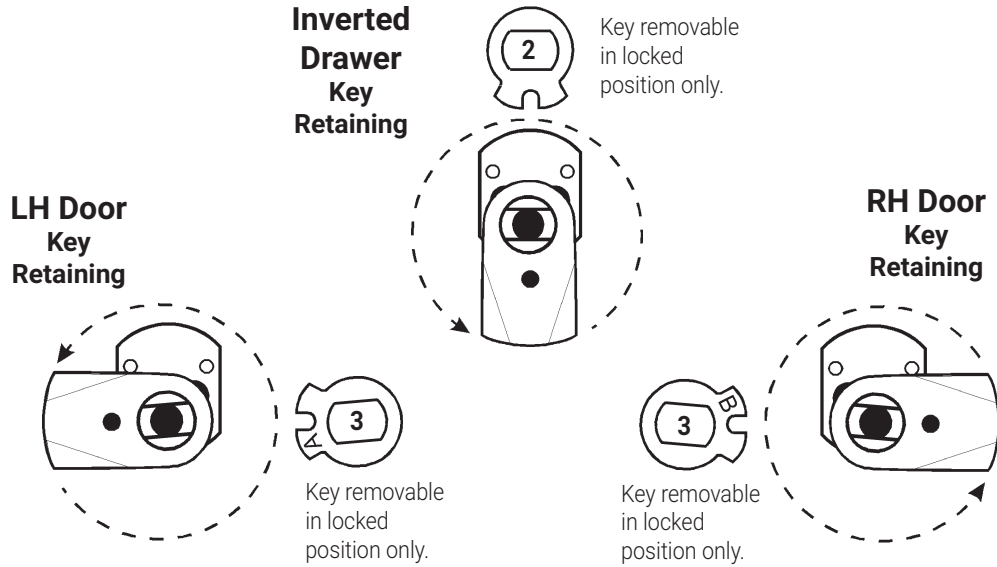
 <p>2 720-KR key retaining drawer cam shifter</p>
 <p>3 720-CDDM (A Side) key retaining door cam shifter</p>
 <p>3 720-CDDM (B Side) key retaining door cam shifter</p>



Assembled with inverted long cam 720-3-3 or 720-3-5

 <p>1 720-CDLM lost motion cam shifter (non-key-retaining)</p>
 <p>2 720-KR key retaining drawer cam shifter</p>

