

700LC | 800LC

LC Series: Less Cylinder Deadbolt Door & Drawer Cabinet Locks



**ANSI/BHMA Grade 1
E07121 | E07041**
**Woodwork Institute (WI)
acknowledged product**

SPECIFICATIONS

Keying: Can be keyed together with other Schlage C Keyway locks

Rekeyable: Easily rekeyable via set screw cylinder release mechanism

ANSI/BHMA: Passed ANSI/BHMA A156.11 Grade 1 performance requirements. Equivalent to E07121 (700S) / E07041 (800S).

US Patent Nos: 4,899,563; 4,920,774

Standard function: Key removable in locked or unlocked position. Standard function locks are non-handed.

Key-retaining: Key removable in locked position only. Specify handing (KL/KR for doors or KI/KV for drawers) when ordering.

Body: Zinc die cast

Cylinder: Will accept other manufacturer's Schlage compatible key-in-knob cylinders

Cylinder length: 1-1/8" or 1-3/8"

Barrel diameter: 1-1/8"

Finish: 26D, US3, 10B

Packaged: Packed 10 per box

KEYING INFORMATION

Keyway: Schlage C keyway

Keys: Includes 2 keys per lock

Cylinder: Solid brass, pin tumbler

Stock keying: KD/KA - 5 pin standard

Stock KA#: 101, 102, O-Bit

Masterkeying: 5 pin standard, 6-pin available

Grand masterkeying: Available

Keyblank 5-pin: KBSC-5

Keyblank 6-pin: KBSC-6

INCLUDED ACCESSORIES

For 1-1/8" barrel length locks:

10-350 plastic spacers (qty 2)

10-054 1/4" plastic bar strike

10-055 1/2" plastic bar strike

For 1-3/8" barrel length locks:

10-054 1/4" plastic bar strike

OPTIONAL ACCESSORIES

Spacers: 10-348 (1/4" thick), 10-349 (1/2" thick), 10-350 (1/8" thick)

Strikes: 10-052, 10-056, 10-057, 10-058, 12-2, 12-3, 12-4

Trim collar: TR78

Through-bolt hardware: ETS1 trim plate, ETS1-PL trim pull and ETST1 template

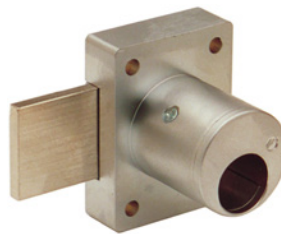

US26D finish



US3 finish



US10B finish

700LC

Function: Cabinet door lock
ANSI/BHMA No.: E07121



US26D finish

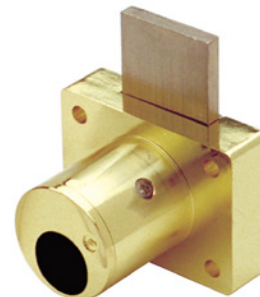

US3 finish



US10B finish

800S

Function: Drawer lock
ANSI/BHMA No.: E07041

INCLUDED ACCESSORIES

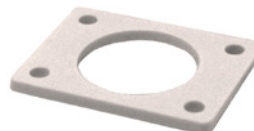

10-350 internal spacers
For a flush fit on varying material thicknesses



10-054 bar strike
1/4" plastic bar strike

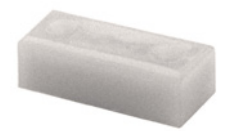

10-055 bar strike
1/2" plastic bar strike

OLYMPUS
LOCK, INC.
The cabinet lock innovators.

700LC | 800LC

ANSI/BHMA Grade 1
E07121 | E07041

LC Series: Less Cylinder Deadbolt Door & Drawer Cabinet Locks

OPTIONAL ACCESSORIES - See our website for a complete list of optional components.

Internal Plastic Spacers

- 10-350 1/8" thick plastic spacers
- 10-348 1/4" thick plastic spacers
- 10-349 1/2" thick plastic spacers

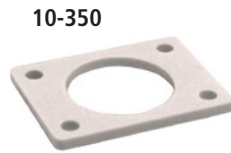

Strikes

- Plastic bar strikes: 10-054, 10-055, 10-057, 10-058. Metal strikes: 10-056 12-1, 12-2, 12-3, 12-4

Trim Ring

- TR78 trim ring

Through-Bolt Mounting Plate

External metal 1/8" or 1/4" through-bolt plate allows for secure and attractive flush mounting of the cabinet lock face. Available in US3 or US26D finish.

- ETS1-125 through-bolt plate, 1/8" thick
- ETS1-250 through-bolt plate, 1/4" thick

ETS1
Through-bolt plate



ETST1
Through-bolt plate
template



U.S. Patent No. D490,686

ETS1-PL
Through-bolt pull

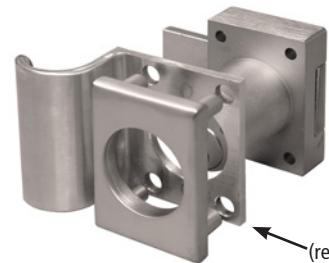

ETS1-PL
(requires use of
ETS1)

Through-Bolt Mounting Plate Template

Allows for proper mounting hole placement of through-bolt plate. Can be used as a 1/8" shim spacer. Available in US3 and US26D finish.

- ETST2 through-bolt plate template

78-KABA-CONV Kaba Conversion Kit

For use with Olympus 700LC and 800LC (less cylinder) cabinet locks. The conversion kit requires the use of the C-form flat washer supplied with the KABA-Peaks cylinder. The washer is needed to keep the Olympus tailpiece on center while operating the lock.

Use with the following cylinders

KABA-Peaks universal cylinder

#3400-XX-1099 (where "XX" denotes finish)

Mul-T-Lock cylinders

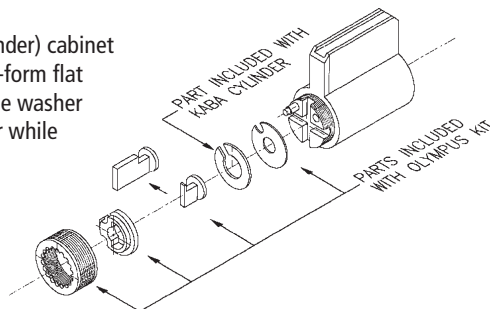

78-201 Series

Schlage C keyway cylinders



SCHLAGE
style C keyway
replacement
cylinder

DIMENSIONS

700LC Cabinet Door Lock

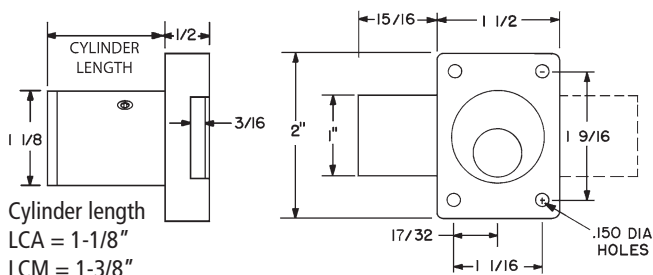

800LC Drawer Lock

