



Bathtub - Madison

Tub mixer for wall-mounted installation with hand shower set - polished chrome

Article number: 25 023 360-00 0010



- 6-1/4" Projection
- Hand shower: Standard spray
- Spout: Rectangular aerator
- Hand shower bracket
- Tub / shower diverter
- Flange diameter 2-3/4"
- 1/2" connection
- Center to center 6"
- Metal shower hose 49-1/4" with anti-twist device
- Spout flow rate max. 6.9 gpm
- Hand shower water flow rate limited to max. 2 gpm
- NOTE: Local building codes may require the use of an anti-scald device. Please refer to remote pressure balance valve (35 910 970 90)
- Internal backflow preventer.



polished chrome



Bathtub - Madison

Tub mixer for wall-mounted installation with hand shower set - polished chrome

Article number: 25 023 360-00 0010

Dimensional drawing

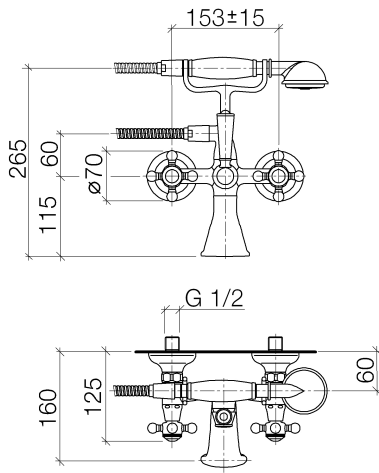

25 023 360-FF

All dimensions in mm / inch = mm x 0,0394

Flow rate chart

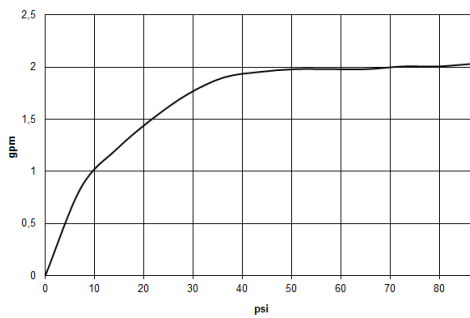



Bathtub - Madison

Tub mixer for wall-mounted installation with hand shower set - polished chrome

Article number: 25 023 360-00 0010

Other surface finishes



platinum matte
25 023 360-06 0010



platinum
25 023 360-08 0010



Durabrass
25 023 360-09 0010

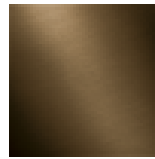

Dark Brass matte
25 023 360-16 0010



Dark Bronze matte
25 023 360-17 0010

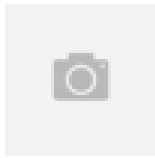

Brushed Durabrass
25 023 360-28 0010

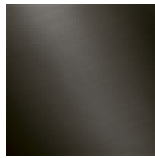

Dark Platinum matte
25 023 360-99 0010

More custom finish options are available via special production (xTra Service). Please see our finish matrix for availability and pricing or contact a Dornbracht representative.

Spare parts list

Number	Item Number	Designation	Number of units
1	28 002 970-00 0010	Metal hand shower with porcelain (white) handle - polished chrome	1
2	28 104 970-00	Metal shower hose 1/2" x 1/2" x 49-1/4" - polished chrome	1
3	09 14 20 002 90	Washer Vf 3110 18,5 x 12,0 x 2,0 mm -	1
4	04 17 20 010 00-00	Holder - polished chrome	1
5	04 20 36 002 07-00	Handle - polished chrome	1
6	09 26 01 011 90	Cover -	1
7	04 15 01 001 00 90	Conversion -	1
8	09 23 10 007 90	Mounting bracket -	1
9	09 30 30 062-00	Cover - polished chrome	1
10	11 170 370-00	Lever insert - polished chrome	1
11	09 28 22 013 90	Mounting bracket -	1
12	09 18 20 011-00	Connecting piece - polished chrome	1
13	09 30 30 064-00	Cover - polished chrome	1

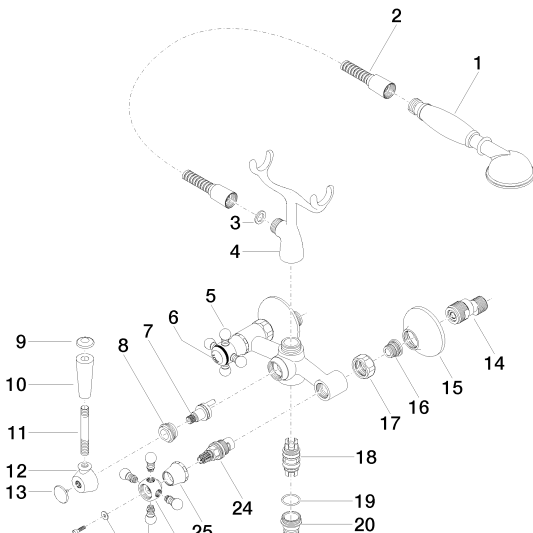

Bathtub - Madison

Tube mixer for wall-mounted installation with hand shower set - polished chrome

Article number: 25 023 360-00 0010

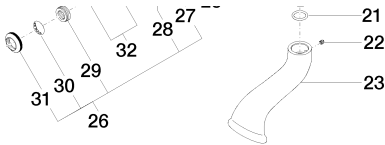

14	04 11 04 030 00 90	S-connector 1/2 x 3/4 -	2
15	09 27 39 010-00	Escutcheon - polished chrome	2
16	04 29 05 014 00 90	Wall connection -	2
17	09 23 30 010-00	Mounting bracket - polished chrome	2
18	04 21 10 010 00 90	Conversion -	1
19	09 14 10 056 90	O-Ring EPDM 70 21,45 x 1,78 mm -	1
20	09 24 03 123 20 90	Nipple -	1
21	09 14 10 022 90	O-Ring EPDM 70 16,0 x 2,5 mm -	1
22	09 31 11 030 90	Mounting bracket -	1
23	09 11 06 033 20-00	Outlet - polished chrome	1
24	90 90 03 131 00 90	Upper part clockwise-closing 1/2" -	2
25	09 21 02 055-00	Hood / sleeve - polished chrome	2
26	04 20 36 002 06-00	Handle - polished chrome	1
27	09 20 36 002-00	Handle - polished chrome	2
28	09 20 36 004-00	Handle - polished chrome	8
29	09 20 83 006 90	Handle -	2
30	09 26 01 010 90	Cover -	1
31	09 20 36 005-00	Handle - polished chrome	2
32	04 30 30 029 00 90	Mounting bracket -	2