



Shower - Tara.

Shower riser - polished chrome

Article number: 26 024 661-00 0010



- Swiveling 180°
- Rainshower
- Rain shower with descaling system
- Rain shower water flow rate limited to max. 1.8 gpm
- Rain shower Ø 11-3/4"
- Showerhead holder with rosette, Ø 3-1/8"
- Metal shower hose 49-1/4" with anti-twist device
- Height from center of faucet to top of shower arm 89-3/4"
- Height from center of faucet to bottom of rainhead 76-3/8"
- Shower head/ hand shower integrated diverter
- Flanges Ø 2-1/8"
- Recommended spacing between bottom edge of shower riser and floor 3-5/8".
- NOTE: Local building codes may require the use of an anti-scald device. Please refer to remote pressure balance valve (35 910 970 90)
- Internal backflow preventer.
- NOTE: Hand shower sold separately. Please see hand shower options under the miscellaneous articles section of each series.
- Rough to be connected to lower wall bracket

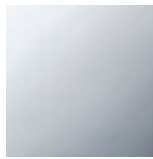

polished chrome

Accessory is required for this item.



Shower - Tara.

Shower riser - polished chrome

Article number: 26 024 661-00 0010

### Dimensional drawing

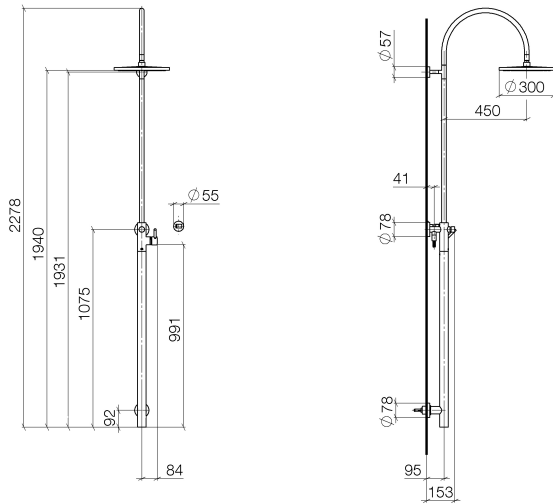

All dimensions in mm / inch = mm x 0,0394



Shower - Tara.

Shower riser - polished chrome

Article number: 26 024 661-00 0010

## Other surface finishes



platinum matte

26 024 661-06 0010



platinum

26 024 661-08 0010

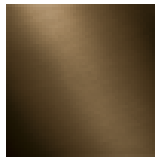

Dark Brass matte

26 024 661-16 0010

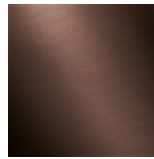

Dark Bronze matte

26 024 661-17 0010



Brushed Durabronze

26 024 661-28 0010

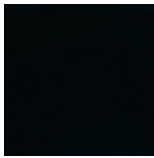

black matte

26 024 661-33 0010

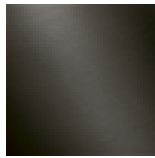

Dark Platinum matte

26 024 661-99 0010

More custom finish options are available via special production (xTra Service). Please see our finish matrix for availability and pricing or contact a Dornbracht representative.

## Required article

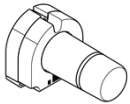

35 003 970-90 0010

Wall mounting -