



Shower - Tara.

Wall bracket - polished chrome

Article number: 28 050 892-00

- Flange diameter 2-1/8"



polished chrome

Dimensional drawing

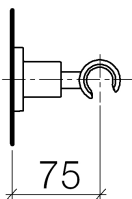
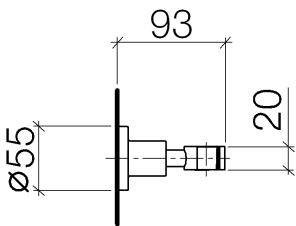

All dimensions in mm / inch = mm x 0,0394



Shower - Tara.

Wall bracket - polished chrome

Article number: 28 050 892-00



Shower - Tara.

Wall bracket - polished chrome

Article number: 28 050 892-00

Other surface finishes



28 050 892-04



platinum matte
28 050 892-06



platinum
28 050 892-08



28 050 892-09



28 050 892-10

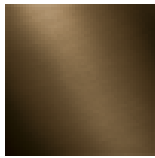

Dark Brass matte
28 050 892-16

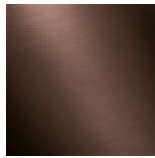

Dark Bronze matte
28 050 892-17

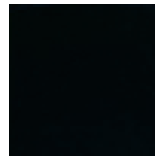

black matte
28 050 892-33



Cyprum
28 050 892-49

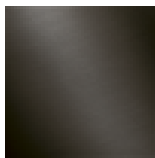

Dark Platinum matte
28 050 892-99

More custom finish options are available via special production (xTra Service). Please see our finish matrix for availability and pricing or contact a Dornbracht representative.

Shower - Tara.

Wall bracket - polished chrome

Article number: 28 050 892-00

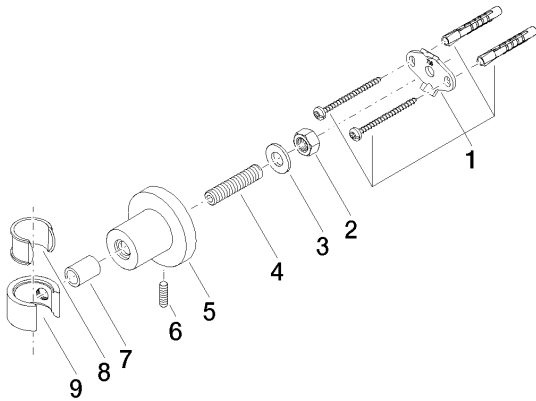

Spare parts list

Number	Item Number	Designation	Number of units
1	05 17 20 739 00 90	Mounting bracket -	1
2	09 23 10 026 90	Mounting bracket -	1
3	09 30 11 046 90	Washer -	1
4	08 18 50 586 90	Pipe -	1
5	08 17 89 505-00	Holder - polished chrome	1
6	04 31 11 113 00 90	Mounting bracket -	1
7	08 17 20 624-00	Hood / sleeve - polished chrome	1
8	09 18 40 035 90	Hood / sleeve -	1
9	09 17 20 014-00	Holder - polished chrome	1