



Bathtub - VAIA

Two-way diverter for deck-mounted tub installation - polished chrome

Article number: 29 140 809-00

- Integrated diverter
- 1-1/8" hole diameter
- Flange diameter 2-3/8"
- 1/2" connection
- Water flow rate limited to max. 17.1 gpm

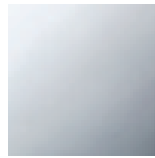

polished chrome

Dimensional drawing

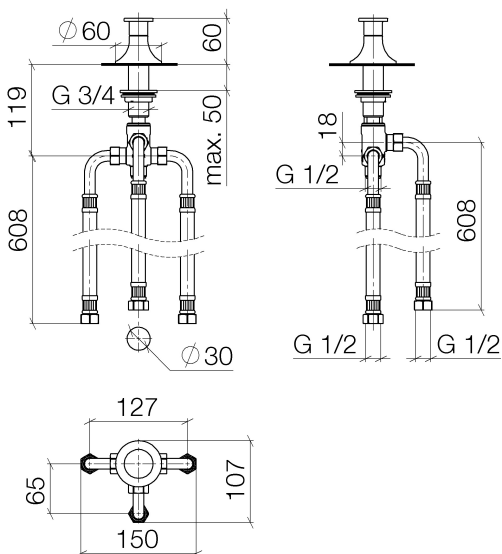

All dimensions in mm / inch = mm x 0,0394



Bathtub - VAIA

Two-way diverter for deck-mounted tub installation - polished chrome

Article number: 29 140 809-00

Flow rate chart

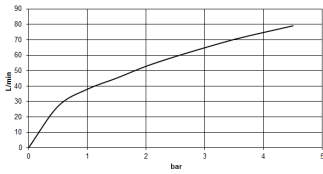



Bathtub - VAIA

Two-way diverter for deck-mounted tub installation - polished chrome

Article number: 29 140 809-00

Other surface finishes



platinum matte
29 140 809-06

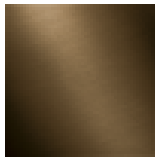

Dark Brass matte
29 140 809-16

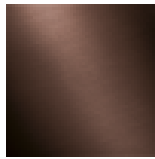

Dark Bronze matte
29 140 809-17

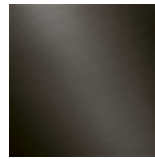

Dark Platinum matte
29 140 809-99

More custom finish options are available via special production (xTra Service). Please see our finish matrix for availability and pricing or contact a Dornbracht representative.

Spare parts list

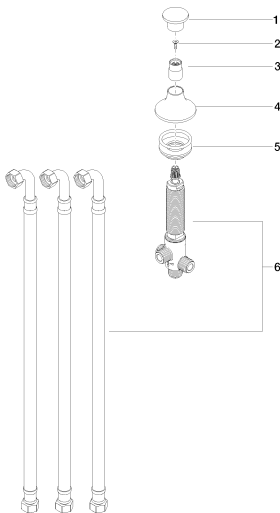

Number	Item Number	Designation	Number of units
1	09 20 80 016-00	Pivot rod/lift knob - polished chrome	1
2	90 30 30 014 00 90	Mounting bracket -	1
3	09 18 40 214-00	Hood / sleeve - polished chrome	1
4	09 27 80 015-00	Escutcheon - polished chrome	1
5	04 23 10 004 03 90	Mounting bracket -	1
6	90 17 09 051 00 90	Conversion -	1