



SCHWINN

Quick Ship Program 8

In stock and ready to ship from
our Arizona warehouse.

To order

Email: sales@schwinhardware.com

Fax: 480.247.5605

Telephone: 480.259.3107

Prices in this book are
suggested retail prices.

www.schwinhardware.com





Flush/Recessed Pull - Lip at Top
Install with screws from back or glue in; panel routed out from front.

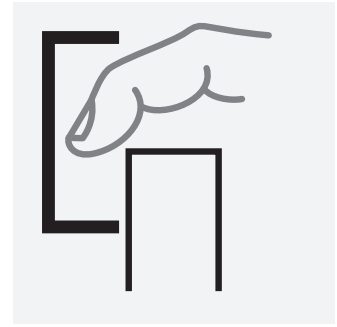

Handle Free Hardware
Channel installed in cabinet box.

Cabinet Hardware Guide

www.schwinnoriginals.com

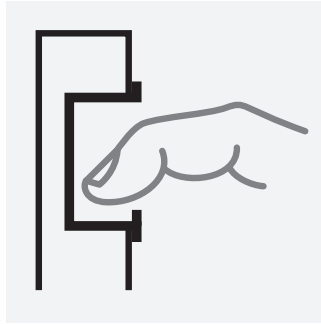

Flush/Recessed Pull - Lip at Bottom
Install with screws from back or glue in; panel routed out from front.

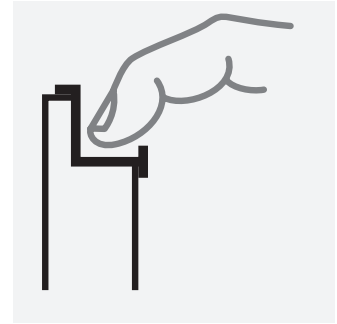

Edge Pull
Install on edge with screws; panel routed out on edge.

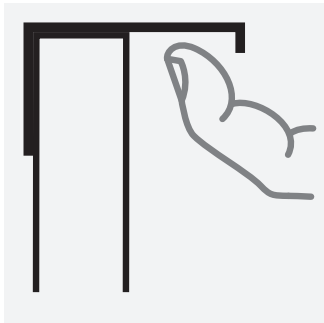

Tab/Edge Pull
Install on edge or over edge with screws; with or without mortise.

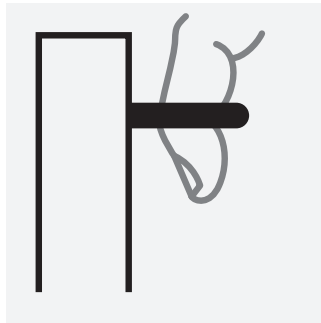

Reach Through Pull
Install with screws through panel.

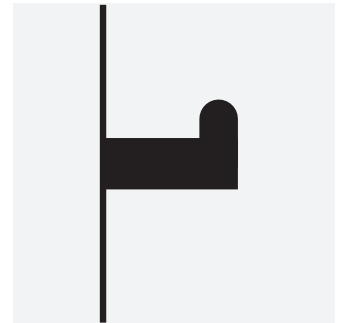

Hook
Concealed or face mounted with bracket, screws and anchors depending on wall conditions.

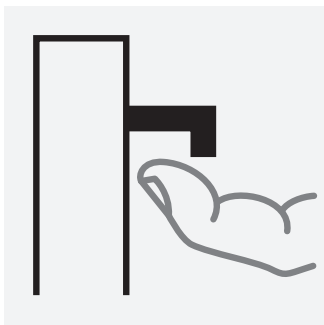

Face Mounted Pull
Install with screws through panel.

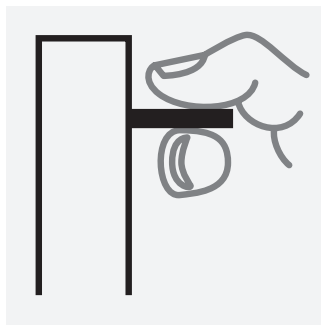

Knob
Install with screw(s) through panel.

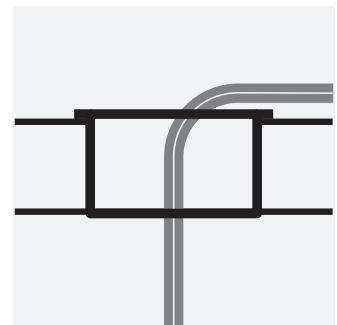

Grommet/Cable Grommet
With or without lid; press fit or glue in hole through counter or panel.

1. Schwinn Hardware – a Story of Dedication

What Peter Schwinn started in 1932 as a workshop in Ober-Ramstadt, Germany (a small town near Frankfurt) using synthetic resin to make furniture handles and knobs, is today one of the leading European manufacturers of furniture hardware. Unlike most hardware companies, Peter Schwinn did not start the company as a blacksmith or metal workshop. He started it to make handles and knobs. For more than 85 years, the company has added many new materials and technologies: stainless steel, aluminum, die-cast zinc, injection-molded plastic, and wood are just a few. But no matter the advances, we always stayed true to one thing: our core-business of furniture hardware. It is this focus, along with our dedication to continuous improvement, that makes Schwinn Hardware a leader in the technology, design, manufacturing, and service of furniture hardware.

So, what do Schwinn Hardware and Schwinn bicycles have in common? Just the name. Ignaz Schwinn, a German who was born in 1860 in a town one hour southeast of Ober-Ramstadt, emigrated to the USA, and in 1895 founded Arnold, Schwinn & Company making bicycles in Chicago. Thirty-seven years later, Peter Schwinn started his furniture hardware company in Germany.

2. Schwinn Hardware Today – a World of Daily Innovation

Today's furniture hardware business is global. Many, many companies from around the world compete on all levels from being the fastest, the cheapest, the hippest, the largest and the most experienced to whatever category a marketing person can come up with. At Schwinn, we have always believed that we are only in business because of our customers.

If we provide them with the best choice of relevant designs, industry leading manufacturing technology, superior quality, shortest possible lead times, great service, and competitive prices they will buy our products to make their furniture better. Furniture that our customers from around the world design, manufacture, build, install, restore, improve, or refresh.



A modern Schwinn factory (Ober-Ramstadt) today.

3. Furniture Hardware – Functional Decoration

Even though the term “decorative hardware” is commonly used to describe the product category that handles and knobs are supposed to belong to, they are far more than just decorative. Warren Plattner, one of America's great architects and furniture designers, recalls that his employer and mentor, Raymond Loewy, the great American Industrial Designer, taught him: “it is worthwhile to pay attention to a very simple object.” For over eight decades we have studied how fingers and hands – small and large, long nailed and thick, wet, or oily – can quickly or slowly grab, touch, feel, pull, push, open, and close drawers and doors, that are high, low, left or right. We designed and manufactured thousands of different designs and then started all over to come up with new and different approaches to solve the same problems. All the while the world of furniture changed and we helped make the changes better with new designs, new technology, new finishes, new materials, and new ways to work with our customers. At Schwinn, we've done our best when a customer loves the furniture that was made better by our hardware.

4. **Hardware in Modern Architecture and Furniture Design**

In his famous 1908 essay “Ornament and Crime”, Adolf Loos (the Moravian born Austrian architect), explained that the relationship between object and ornament was a moral one based on the conviction that the ornament causes objects to go out of style and the effort that goes into the ornamentation is wasted and thus a crime. It was also the Moravians who built the town of Salem, now Old Salem, in North Carolina, and for those who have seen it, they will recall the lack of ornamentation in the buildings and furniture. “Ornament and Crime” was a major contribution to modernist architectural theory and a new era. It was the same era in which Peter Schwinn started his company. Bauhaus architects like Breuer and Mies van der Rohe, as well as De Stijl architects like Rietveld, developed a new language for their furniture hardware. It was tool-like, functional, and without surface decoration. It was modern. Since then modern hardware design has taken many different directions. From Aalto’s organic designs; Eames’s utilitarian use of wire pulls; and Neutra’s total elimination of hardware for built-in furniture to Girard’s and Nelson’s mid-century modern exuberant designs, to the post-modern whimsical Starck. But rarely has a specific handle or knob become known for the designer who designed it.

5. **Measurements – Inches to Millimeters**

Our standard of measure is the millimeter. When making small objects like handles and knobs, the millimeter is an appropriately precise unit. It can easily be converted into fractions of an inch, but that is a task we want to help you with. For that reason, we have included a conversion table so you can have it both ways. All measurements appear in the same order: width, height, and depth. Those measurements describe the handle or knob. Then there is “center to center” for the distance between taps. Sometimes there are C/C options for the same handle. Sometimes there is only one thread. In that case we have made sure by design that the knob will stay in place and will not accidentally twist.

6. **Materials: Zamak – 95% of the Purest Zinc, Plus Aluminum, Magnesium and Copper in a Standardized Combination**

The invention of Zamak is a great American story of ingenuity. Developed and trademarked by the New Jersey Zinc Company in 1929, it solved two big problems: zinc itself is a brittle, low strength, and low hardness metal. However, the addition of three other metals transformed it and made it comparable (even superior) to other cast metals such as aluminum, magnesium, brass, and cast iron. In order to maintain the great mechanical properties of this alloy and to avoid the problem of zinc pest commonly caused by other zinc alloys at the time, New Jersey’s research showed that they needed to use zinc that was 99.99% free of impurities.

To produce this never-before available grade they used a special refluxer during the smelting process to separate the wanted from the unwanted. The name Zamak itself is an acronym of the German words for the metals Zink (zinc), aluminium (aluminum), Magnesium (magnesium) and Kupfer (copper). Today there are several different Zamak alloys. With over 70% share, Zamak 3 is the most common Zamak used in the United States for hot chamber die-casting to make parts in industries ranging from cars and airplanes to household appliances. Schwinn hardware is made with Zamak 5 (European Standard EN 1774) which has 1% copper added to make it stronger and harder than Zamak 3.

7. **Materials: Brass – Zinc Again and Mainly Copper (in Many Different Combinations)**

Brass is a generic term for a very broad range of copper-zinc alloys (not to be confused with bronze, which is a copper-tin alloy). Unlike Zamak, brass has no clear specification as to how much copper and zinc it has to contain. Different brasses consist of between 15 to 50% and more zinc, and 50 to 85% copper, sometimes additionally with some lead, tin, or aluminum.

This makes for very different qualities of materials that are all called brass. Decorative hardware made of brass is often stamped, forged, die-cast, or sand-cast, however, none of these techniques allows for the same complex shapes, close tolerances, and range of variation in thickness and economical finishing as Zamak. To protect the beautiful muted yellow color or to give brass hardware a chrome, nickel, or colored finish it is usually treated in similar ways as Zamak. It is then first the quality of the finish that determines how the part performs over time.

8. **Materials: Aluminum – or Is It Aluminum Alloy?**

Aluminum – unlike Zamak or brass – is not an alloy; however, due to high shrinkage, aluminum is rarely ever used in its pure form to cast or extrude parts like decorative hardware. So again copper, magnesium, manganese, silicon, and zinc are added in various degrees to create the desired properties. There are many different aluminum alloys available and they all have different benefits, advantages, and usages. And even though aluminum is naturally corrosion-resistant, aluminum alloys are less so. That is why there is a “marine grade” aluminum.

Schwinn hardware is made with an aluminum alloy called Al Mg Si 0,5 (European Standard 3.3206). A good corrosion resistance material that we make even higher with our anodized finishes.

9. **Materials: Stainless Steel – It’s the Chromium That Makes the Steel Corrode Less (and Shiny When Polished)**

Since the 19th-century it was known that adding chromium to steel (another alloy) gives ordinary steel a special resistance to corrosion. A process called passivation creates a layer of chromium oxide on the surface so thin that the metal is still lustrous, but thick enough to prevent the corrosion process to spread into the material. It is the same process that occurs on aluminum and titanium. A minimum of 11% of chromium in the steel is required. The more the better. Over 150 different grades of stainless steel are available today with up to 26% chromium, some with nickel, molybdenum, aluminum, titanium, or manganese depending on the desired properties.



Zamak ingots ready for production.

10. Materials: Steel – Mostly Iron, with Little or No Carbon

Simply speaking, if it is not stainless steel it is carbon steel. Just as there are many different alloys that we call stainless steel there are even more that we call carbon steel. All of them are steel alloys containing nickel, molybdenum, aluminum, titanium, or manganese to name a few. Steel with very low carbon content and some fibrous slag is known as wrought iron. The manufacture of this product – with its beautiful wood-like grain – declined in the 1950's due to the high cost of production. Even though the term wrought iron is often still used in hardware, the material it refers to has been replaced with mild steel (low but not as low as carbon content steel).

As an economical choice certain types of handles like wire pulls can be made of steel and finished in many high-quality finishes, especially powder coating.



A die-casting tool in the making at the Schwinn tool shop.

11. Materials: Plastic – It Created a Stir at the 1862 International Exhibition in London

When Alexander Parkes presented this new material he had derived from cellulose and called Parkesine – the first man-made plastic – at the 1862 International Exhibition London, people were fascinated. But Parkesine was expensive, prone to cracking, and highly flammable. A few years later, in 1868, the American inventor John Wesley Hyatt developed a plastic material he named Celluloid improving on Parkes' invention so that it could be processed into finished form. Together with his brother Isaiah, Hyatt patented the first injection-molding machine in 1872, which was quickly used to make things like buttons and combs. Today there are thousands of different plastics that are injection-molded into almost everything including furniture hardware.

An economical choice, injection-molded handles, knobs, legs, and grommets play a big role in the modern furniture industry and Schwinn provides an increasingly large share of innovative products for that market.

12. Production: Die-Casting – a Process Born in the USA

First invented in 1876 in America by the German Ottmar Mergenthaler for the printing industry, the process of forcing molten metal under high pressure into mold cavities was quickly refined and as a result, it caught on in many industries. Today it is used worldwide to manufacture parts of high-fluidity metal alloys including Zamak, brass, bronze, and magnesium. The parts have excellent dimensional accuracy, smooth cast surfaces (or textured if desired), allow thinner walls when compared to sand cast or permanent mold casting, and great tensile strength which makes it ideal to manufacture complex, high quality, modern design furniture hardware.

However, to produce a perfect part the tool has to be perfect. That's why we have our own Schwinn tool workshop. Highly trained and experienced workers know every important detail of the process and make sure that our furniture hardware is made on the best possible and longest lasting tools.



Die-casting machines in action at a Schwinn factory.

**13.
Production: Extruding –
by the Inch, Foot, or Yard**

Extrusion is a process used to create objects of a fixed cross-sectional profile. A material is pushed or drawn through a die of the desired cross-section that can be as simple as a tube or the complex profile of a furniture handle. Although known since the 18th-century, it was not until the 19th-century and the invention of the hydraulic powered press, that the extrusion process was commonly used for lead, and then late in the 19th-century for copper and brass alloys. Today aluminum is the most commonly extruded material. The two main advantages of this process over other manufacturing processes are the ability to create very complex cross-sections and to work with brittle materials. The finished parts have an excellent surface finish – an important requirement for furniture hardware.

**14.
Production: Injection
Molding – the Era
That Started in 1946**

Injection molding is to thermoplastics what die-casting is to metal. Back in 1872, the American John Wesley Hyatt and his brother invented a machine that basically pushed plastic through a plunger into a mold. But it was in 1946 that the screw injection machine by American James Watson Hendry first allowed precise control over the speed of the process and quality of the produced parts. To this day it is still the most economical way to produce large amounts of parts of an ever-increasing amount of materials and possibilities that we call plastics. As one of the leading suppliers to the furniture industry, Schwinn uses ABS, a tough and recyclable plastic, to produce a broad range of high-quality parts from handles and grommets to furniture legs.

**15.
Finishes: More Than
Just a Pretty Face**

Many desired properties of furniture hardware, such as resistance to abrasion, wear, acidic liquids, and corrosion, as well as color, luster, sheen, and feel are not accomplished by the primary material used to shape the product, but instead by its finish. It is the finish that often makes the difference between good and great; appropriate or inappropriate for a specific purpose or environment; lasting or short lived. There are many finishes to choose from. Their qualities vary greatly and the differences are much deeper than it appears.

16. Finishes 1: Electroplating – What You Don't See Is What Matters

Technically, electroplating is a process in which metal ions (e.g., nickel, copper, chromium, etc.) in a solution are moved by an electric field to coat an electrode like a piece of hardware. Plating is a non-leveling coating. Any imperfection in the cast piece will show. That means the surface has to be finished and buffed or brushed (if a brushed finish is desired) to perfection first. Schwinn employs highly skilled workers with many years of experience for this critical job. Just as the preparation is important for the appearance of the finished piece, so is the cleaning for its durability.

There is even a standard for that: ASTM B3222. After all that is done it is time for several rounds of plating. At Schwinn, we first use a layer of copper, then another layer of copper, then nickel, and finally chromium to achieve our high-quality chrome finish. During this process each part goes through over 40 different baths to ensure perfect and lasting quality.

17. Finishes 2: Anodizing – like Nature, Only Thicker

Mostly known and used as a finish for aluminum, anodizing increases the thickness of the aluminum oxide layer that is naturally formed when aluminum is exposed to air. With some chemicals, electricity and a well-prepared surface the anodized part gets an oxide layer that will make it highly corrosion resistant. Since this layer is quite porous it can easily absorb dyes allowing for a nice range of colors. The final step is the application of a sealer – a critical step that keeps the dye from discoloring and seals the surface against corrosion.



18. Finishes 3: Powder-Coating – High Performance Finish

Because powder coating uses an electric charge and no solvent it can be applied much thicker than liquid paint. In fact Schwinn powder-coated finishes are 5-10 times thicker than lacquer. After preparing the piece the powder is applied with a spray gun and then cured at around 400F. The result is a beautifully smooth, highly durable finish. Schwinn AM Antimicrobial Protected Furniture Hardware features an innovative high performance finish that inhibits microbial growth adding the value of product protection to the design and quality of Schwinn Hardware. It has proven to resist over 1000 hours of salt spray (ASTM-B117) and over 1000 hours of humidity (ASTM-D2247). With its additional excellent scratch resistance, chemical resistance, and adhesion, our performance finish is setting new standards in the industry. For more information please go to www.schwinnhardware.com.



Schwinn's fully automated, high volume powder coating machine.

The Agion Antimicrobial is not intended as a substitute to good hygiene. It does not protect users or others against disease-causing bacteria. Coated products must still be cleaned to insure the surfaces will be free of destructive microbes. Schwinn Hardware makes no representations or warranties, expressed or implied as to the efficacy of the Agion Antimicrobial. Agion is a registered trademark of Scieissant LLC, Wakefield, MA, USA. Cradle to Cradle (CM) is a certification mark of MBDC.

19. Finishes 4: Lacquering – Thin and Smooth Protection

An inexpensive way to achieve a smooth protective coating is the application of a clear or colored varnish that dries by solvent evaporation. Schwinn uses only environmentally friendly water based lacquers. Surface preparation, cleanliness, and the quality of the lacquer are of highest importance in achieving a smooth film that lasts over time.



Schwinn's eco-friendly lacquering machine uses only water-based products.

20. Standards for Hardware

Product safety and performance, as well as the environmental impact of the production and use of furniture hardware, are regulated by various standards in different industries and countries. One important US standard is ANSI A 156.9.2010 which was developed by the Builders Hardware Manufacturers Association and then adopted by the Kitchen Cabinet Manufacturers Association KCMA. Continuous improvements on all levels make sure that Schwinn products always meet or exceed national and international standards.

LEED. Leadership in Energy and Environmental Design, is the most widely recognized and used green building program across the globe. It is instituted by the United States Green Building Council. LEED is certifying 1.6 million square feet of building space each day in more than 130 countries. LEED is a certification program for buildings, homes and communities that guides the design, construction, operations and maintenance. Nearly 50,000 projects are currently participating in LEED, comprising more than 8.9 billion square feet of construction space. Because handles and knobs are usually less than 5% of the product by weight (e.g., the desk) these parts generally do not contribute to LEED points.

Level. The Level certification process follows the LEED ratings. Instead of being a rating for buildings however it is a rating for all business and institutional furniture manufacturers as well as for the suppliers of materials and components. The implications for furniture hardware like knobs and handles are the same as for LEED.

RoHS. Restriction of Hazardous Substances, was adopted by the European Union in 2003 and took effect in 2006. Lead, Mercury, and Hexavalent Chrome are three of the six substances that are targeted and relevant to furniture hardware components. Maximum permitted concentrations are 1000ppm. Schwinn products are in compliance with RoHS.

21. ADA Considerations

The Americans with Disabilities Act (ADA) is the most comprehensive civil rights legislation adopted to prohibit discrimination against people with disabilities. The ADA was signed into law on July 26, 1990.

Title III prohibits discrimination by private entities and nonprofit service providers operating public accommodations. This includes privately operated entities that offer licenses and exams, private schools and colleges, banks, restaurants, theaters, hotels, private transportation, supermarkets, shopping malls, museums, health clubs and other recreational facilities, sports arenas, doctor, lawyer and insurance offices, and other commercial facilities.

Public accommodations must not exclude, segregate or treat people with disabilities unequally. This includes compliance with architectural standards providing physical access.

Guidelines. Drawer handles fall under section 4.25.4 of the ADA Standards for Accessible Design as hardware for storage facilities. "4.25.4 Hardware. Hardware for accessible storage facilities shall comply with 4.27.4. Touch latches and U-shaped pulls are acceptable." Further detail comes from section 4.27.4: "Controls and operating mechanisms shall be operable with one hand and shall not require tight grasping, pinching, or twisting of the wrist. The force required to activate controls shall be no greater than 5 lbf." Based on these guidelines we have noted for each item in this catalog whether or not we consider it in compliance with ADA.

Schwinn Item 22766/32 Knob

Material: Zamak

Environmental Information:

- Fully Recyclable
 - Meets RoHS Standards
- ADA Compliant: No

41 x 41 x 24 mm

C/C 32; M4 Thread

Matte Black \$12.00

Order Nr. 59408

Matte Gold \$13.00

Order Nr. 59410

Satin Nickel \$12.00

Order Nr. 59409

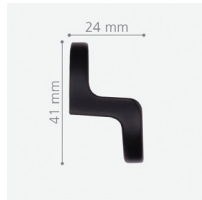
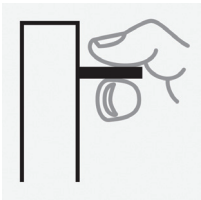

Schwinn Item 44141 Knob

Material: Stainless Steel Grade 303; Steel

Environmental Information:

- Fully Recyclable
 - Meets RoHS Standards
- ADA Compliant: No

20 x 33 mm

C/C 0; M4 Thread

Brushed Stainless Steel \$12.00

Order Nr. 51970

Polished Chrome \$12.00

Order Nr. 59381

Matte Black \$12.00

Order Nr. 59380

Matte Gold \$13.00

Order Nr. 59379

Satin Nickel \$12.00

Order Nr. 59382

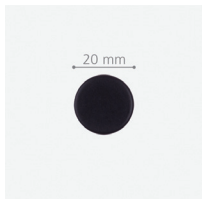
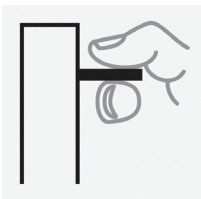

Schwinn Item 22607 Knob

Material: Zamak
 Environmental Information:
 - Fully Recyclable
 - Meets RoHS Standards
 ADA Compliant: No

26 x 26 x 20 mm C/C 0; M4 Thread	
Polished Chrome Order Nr. 59078	\$11.00
Matte Black Order Nr. 59344	\$10.00
Matte Gold Order Nr. 59343	\$11.00
Satin Nickel Order Nr. 52555	\$10.00

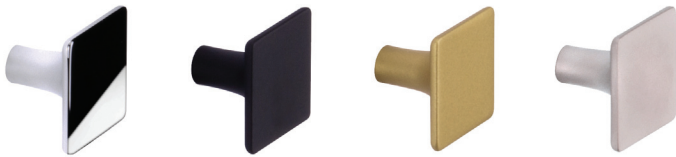
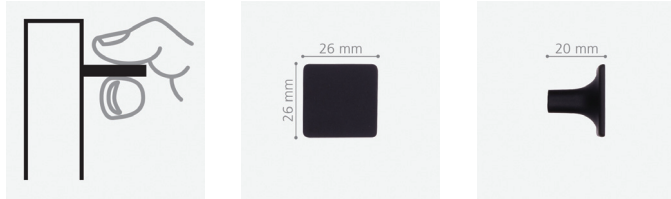

Schwinn Item 22022 Knob

Material: Zamak
 Environmental Information:
 - Fully Recyclable
 - Meets RoHS Standards
 ADA Compliant: No

32 x 22 mm C/C 0; M4 Thread	
Polished Chrome Order Nr. 50701	\$11.00
Matte Black Order Nr. 59342	\$10.00
Matte Gold Order Nr. 59341	\$11.00
Satin Nickel Order Nr. 50700	\$10.00
Dark Nickel Order Nr. 59074	\$11.00

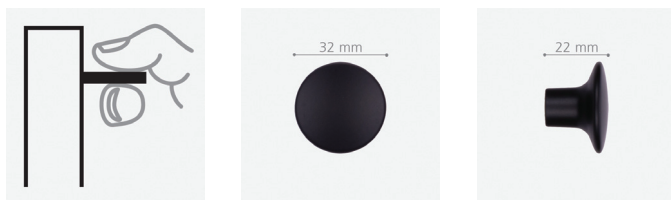

Schwinn Item 22935/32 Pull

Material: Zamak

Environmental Information:

- Fully Recyclable
 - Meets RoHS Standards
- ADA Compliant: No

50 x 50 x 24 mm

C/C 32 mm; M4 Thread

Polished Chrome \$16.00

Order Nr. 52901

Matte Black \$16.00

Order Nr. 59419

Matte Gold \$18.00

Order Nr. 59338

Satin Nickel \$16.00

Order Nr. 59420

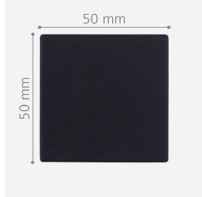
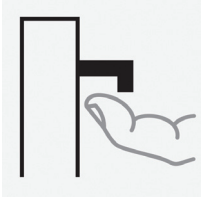

Schwinn Item 2Z199/32 Knob

Material: Zamak

Environmental Information:

- Fully Recyclable
- Meets RoHS Standards
- ADA Compliant: No

52 x 14 x 25 mm

C/C 32 mm; M4 Thread

Polished Chrome \$11.00

Order Nr. 59139

Satin Nickel \$11.00

Order Nr. 59138

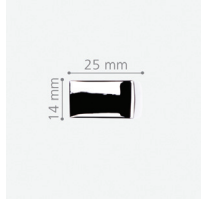
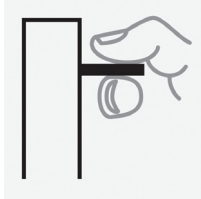

Schwinn Item 2Z198/16 Pull

Material: Zamak

Environmental Information:

- Fully Recyclable
- Meets RoHS Standards
- ADA Compliant: No

27 x 44 x 32 mm

C/C 16 mm; M4 Thread

Polished Chrome \$16.00

Order Nr. 53896

Satin Nickel \$16.00

Order Nr. 59130

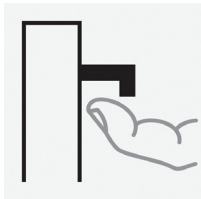

Schwinn Item 22273/160 Pull

Material: Zamak

Environmental Information:

- Fully Recyclable
 - Meets RoHS Standards
- ADA Compliant: Yes

174 x 14x 31 mm

C/C 160 mm; M4 Thread

Polished Chrome \$14.00

Order Nr. 54298

Matte Black \$12.00

Order Nr. 59384

Matte Gold \$14.00

Order Nr. 59385

Satin Nickel \$13.00

Order Nr. 59383

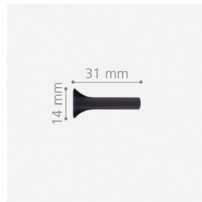
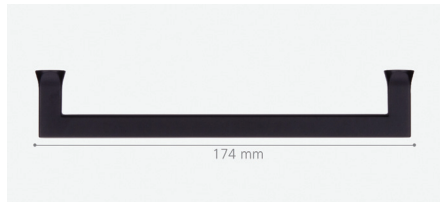
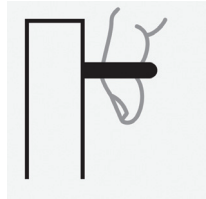

Schwinn Item 22114/128 Pull

Material: Zamak

Environmental Information:

- Fully Recyclable
 - Meets RoHS Standards
- ADA Compliant: No

147 x 12 x 20 mm

C/C 128 mm; M4 Thread

Polished Chrome \$21.00

Order Nr. 59110

Matte Black \$20.00

Order Nr. 59480

Satin Nickel \$20.00

Order Nr. 59111

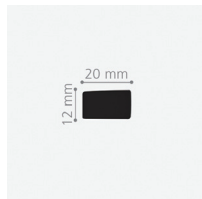
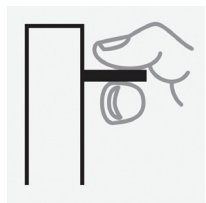

Schwinn 34043 Series

Material: Steel/Zamak
 Environmental Information:
 - Fully Recyclable
 - Meets RoHS Standards
 ADA Compliant: Yes

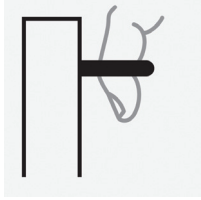

Schwinn Item 34043/64 Pull

73 x 9 x 28 mm C/C 64 mm; M4 Thread	
Matte Black/ Matte Chrome Order Nr. 59206	\$8.00
Matte Black/Matte Black Order Nr. 59208	\$8.00
Matte Gold/Matte Gold Order Nr. 59207	\$9.00

Schwinn Item 34043/128 Pull

137 x 9 x 28 mm C/C 128 mm; M4 Thread	
Matte Black/ Matte Chrome Order Nr. 59209	\$10.00
Matte Black/Matte Black Order Nr. 59211	\$10.00
Matte Gold/Matte Gold Order Nr. 59210	\$11.00

Schwinn Item 34043/192 Pull

201 x 9 x 28 mm C/C 192 mm; M4 Thread	
Matte Black/ Matte Chrome Order Nr. 59212	\$12.00
Matte Black/Matte Black Order Nr. 59214	\$12.00
Matte Gold/Matte Gold Order Nr. 59213	\$13.00

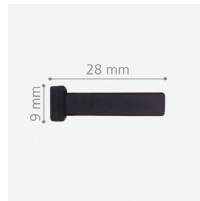
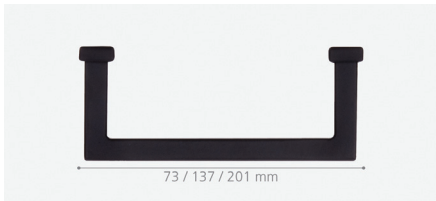

Available Sizes

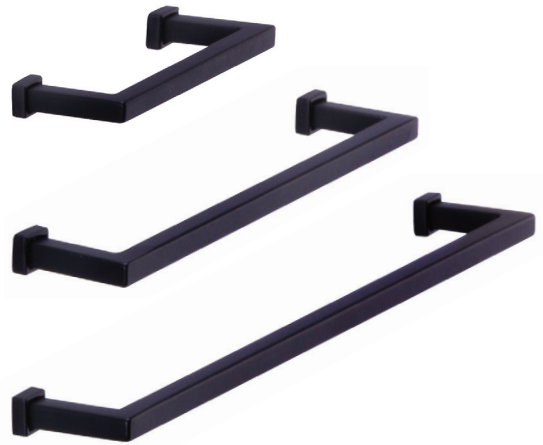

Available Finishes



Schwinn 22334 Series

Material: Zamak

Environmental Information:

- Fully Recyclable
 - Meets RoHS Standards
- ADA Compliant: Yes

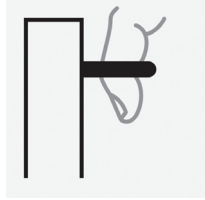

Schwinn Item 22334/128 Pull

138 x 10 x 30 mm

C/C 128 mm; Thread M4

Polished Chrome	\$23.00
Order Nr. 51749	
Matte Black	\$19.00
Order Nr. 59371	
Matte Gold	\$22.00
Order Nr. 59373	
Satin Nickel	\$18.00
Order Nr. 51747	
Satin Nickel Performance Finish	\$19.00
Order Nr. 59046	
Dark Nickel	\$20.00
Order Nr. 59096	

Schwinn Item 22334/192 Pull

202 x 10 x 30 mm

C/C 192 mm; Thread M4

Polished Chrome	\$25.00
Order Nr. 59181	
Matte Black	\$22.00
Order Nr. 59372	
Matte Gold	\$25.00
Order Nr. 59374	
Satin Nickel	\$21.00
Order Nr. 59180	
Satin Nickel Performance Finish	\$22.00
Order Nr. 59045	
Dark Nickel	\$22.00
Order Nr. 59097	

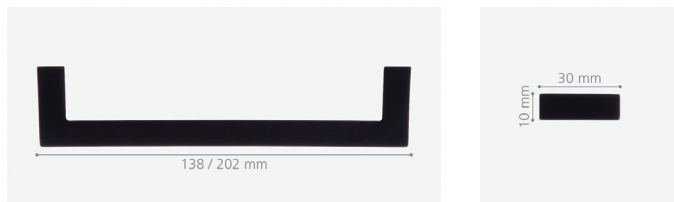

Available Sizes



Available Finishes

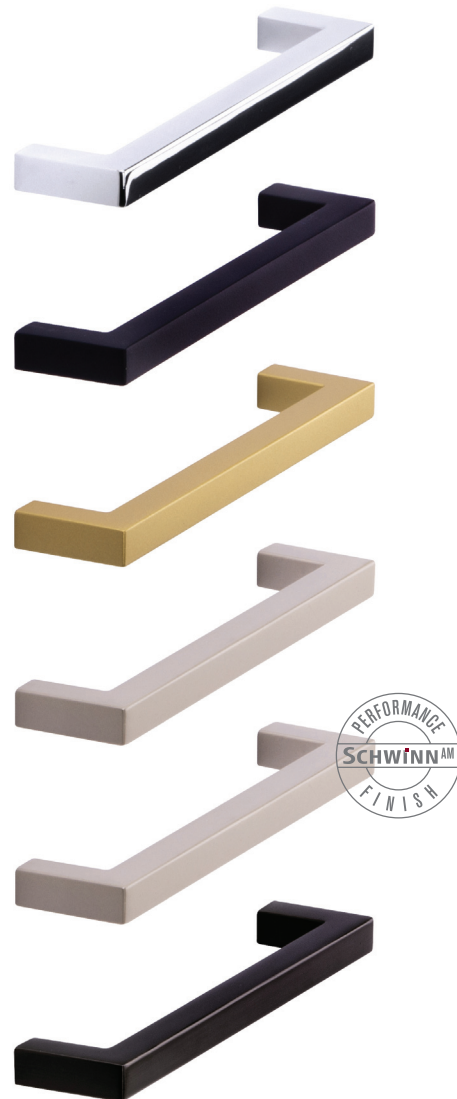

Schwinn 22548 Series

Material: Zamak
 Environmental Information:
 - Fully Recyclable
 - Meets RoHS Standards
 ADA Compliant: Yes

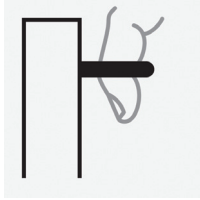

Schwinn Item 22548/128 Pull

158 x 9 x 26 mm

C/C 128 mm; M4 Thread

Matte Black \$17.00

Order Nr. 59432

Matte Gold \$17.00

Order Nr. 59431

Satin Nickel \$16.00

Order Nr. 59027

Dark Nickel \$16.00

Order Nr. 59099

Schwinn Item 22548/192 Pull

226 x 9 x 27 mm

C/C 192 mm; M4 Thread

Matte Black \$20.00

Order Nr. 59434

Matte Gold \$20.00

Order Nr. 59433

Satin Nickel \$19.00

Order Nr. 59028

Dark Nickel \$19.00

Order Nr. 59100

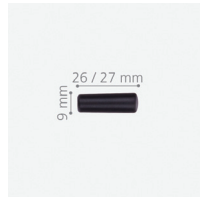

Available Sizes



Available Finishes

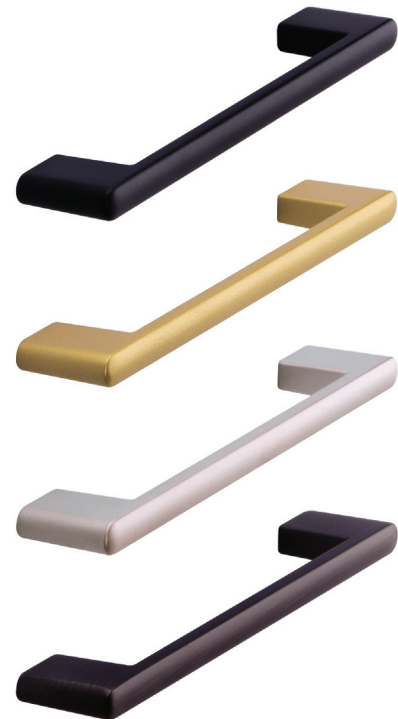

Schwinn 22389 Series

Material: Zamak

Environmental Information:

- Fully Recyclable

- Meets RoHS Standards

ADA Compliant: Yes

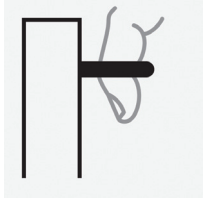

Schwinn Item 22389/64 Pull

72 x 17 x 28 mm

C/C 64 mm; M4 Thread

Polished Chrome	\$14.00
-----------------	---------

Order Nr. 54230

Matte Black	\$14.00
-------------	---------

Order Nr. 59355

Matte Gold	\$14.00
------------	---------

Order Nr. 59362

Satin Nickel	\$14.00
--------------	---------

Order Nr. 52834

Dark Nickel	\$14.00
-------------	---------

Order Nr. 59089

Schwinn Item 22389/128 Pull

137 x 20 x 30 mm

C/C 128 mm; M4 Thread

Polished Chrome	\$19.00
-----------------	---------

Order Nr. 54232

Matte Black	\$19.00
-------------	---------

Order Nr. 59356

Matte Gold	\$19.00
------------	---------

Order Nr. 59363

Satin Nickel	\$19.00
--------------	---------

Order Nr. 51877

Dark Nickel	\$19.00
-------------	---------

Order Nr. 59090

Schwinn Item 22389/160 Pull

168 x 20 x 30 mm

C/C 160 mm; M4 Thread

Polished Chrome	\$20.00
-----------------	---------

Order Nr. 54233

Matte Black	\$20.00
-------------	---------

Order Nr. 59357

Matte Gold	\$20.00
------------	---------

Order Nr. 59364

Satin Nickel	\$20.00
--------------	---------

Order Nr. 52836

Dark Nickel	\$20.00
-------------	---------

Order Nr. 59091

Schwinn Item 22389/192 Pull

200 x 20 x 30 mm

C/C 192 mm; M4 Thread

Polished Chrome	\$22.00
-----------------	---------

Order Nr. 54234

Matte Black	\$22.00
-------------	---------

Order Nr. 59358

Matte Gold	\$22.00
------------	---------

Order Nr. 59365

Satin Nickel	\$22.00
--------------	---------

Order Nr. 53172

Dark Nickel	\$22.00
-------------	---------

Order Nr. 59092

Available Sizes

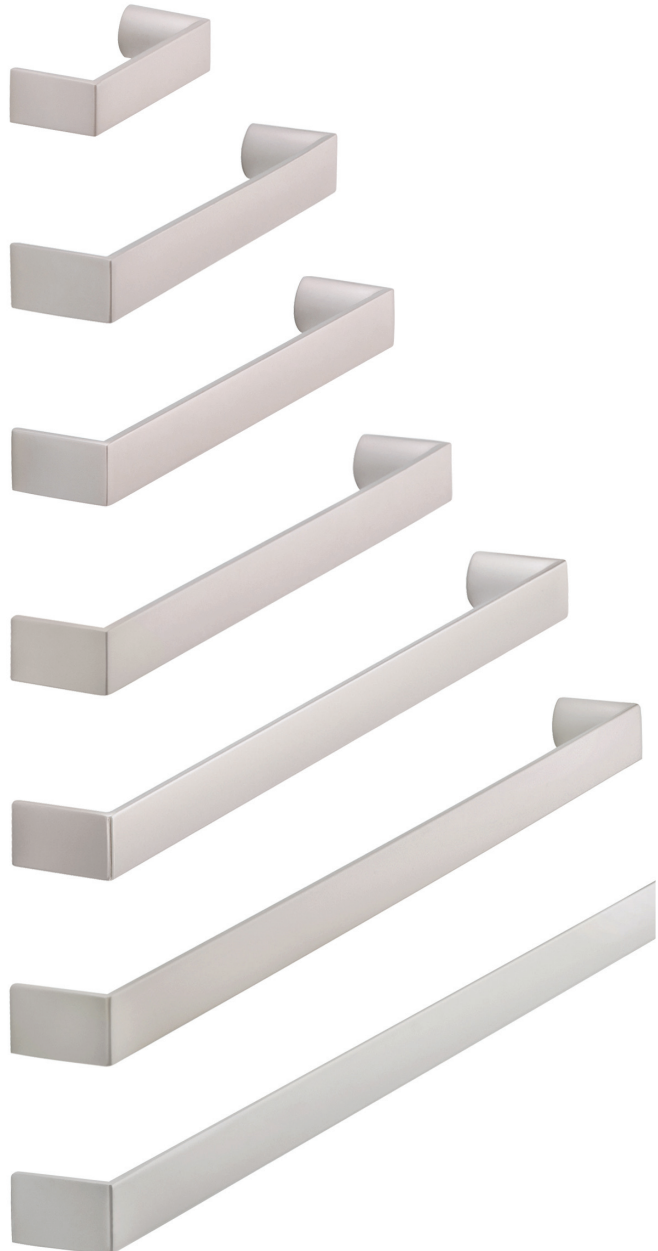

Schwinn Item 22389/256 Pull

264 x 20 x 30 mm

C/C 256 mm; M4 Thread

Polished Chrome	\$38.00
Order Nr. 54235	
Matte Black	\$38.00
Order Nr. 59359	
Matte Gold	\$38.00
Order Nr. 59366	
Satin Nickel	\$38.00
Order Nr. 52837	
Dark Nickel	\$38.00
Order Nr. 59093	

Schwinn Item 22389/320 Pull

328 x 20 x 30 mm

C/C 320 mm; M5 Thread; Appliance Pull

Polished Chrome	\$42.00
Order Nr. 59369	
Matte Black	\$42.00
Order Nr. 59360	
Matte Gold	\$42.00
Order Nr. 59367	
Satin Nickel	\$42.00
Order Nr. 59087	
Dark Nickel	\$42.00
Order Nr. 59094	

Schwinn Item 22389/480 Pull

488 x 20 x 30 mm

C/C 480 mm; M5 Thread; Appliance Pull

Polished Chrome	\$52.00
Order Nr. 59370	
Matte Black	\$52.00
Order Nr. 59361	
Matte Gold	\$52.00
Order Nr. 59368	
Satin Nickel	\$52.00
Order Nr. 59088	
Dark Nickel	\$52.00
Order Nr. 59095	

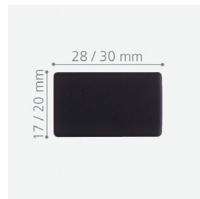

Available Finishes



Schwinn 2Z306 Series

Material: Zamak

Environmental Information:

- Fully Recyclable
 - Meets RoHS Standards
- ADA Compliant: Yes

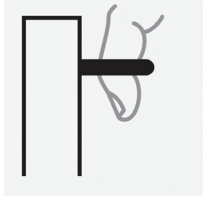

Schwinn Item 2Z306/64 Pull

74 x 10 x 29 mm

C/C 64 mm; M4 Thread

Polished Chrome	\$10.00
Order Nr. 59022	
Matte Black	\$10.00
Order Nr. 59017	
Matte Gold	\$11.00
Order Nr. 59016	
Satin Nickel	\$10.00
Order Nr. 59014	
Dark Bronze	\$11.00
Order Nr. 59015	

Schwinn Item 2Z306/128 Pull

138 x 10 x 30 mm

C/C 128 mm; M4 Thread

Polished Chrome	\$15.00
Order Nr. 59039	
Matte Black	\$14.00
Order Nr. 59038	
Matte Gold	\$15.00
Order Nr. 59037	
Satin Nickel	\$14.00
Order Nr. 59035	
Dark Bronze	\$15.00
Order Nr. 59036	

Schwinn Item 2Z306/160 Pull

170 x 10 x 30 mm

C/C 160 mm; M4 Thread

Polished Chrome	\$16.00
Order Nr. 59179	
Matte Black	\$16.00
Order Nr. 59178	
Matte Gold	\$17.00
Order Nr. 59177	
Satin Nickel	\$16.00
Order Nr. 59040	
Dark Bronze	\$17.00
Order Nr. 59042	

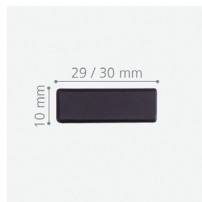
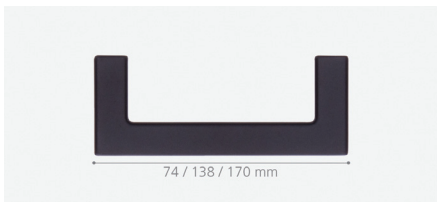

Available Sizes

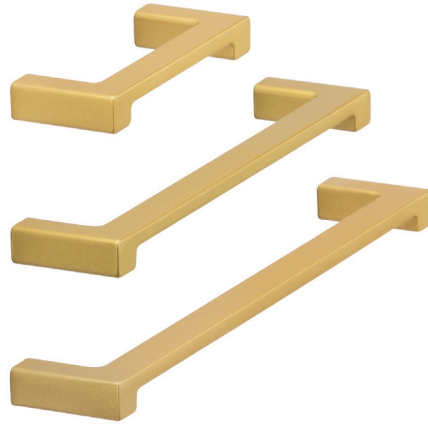

Available Finishes



Schwinn 2Z395 Series

Material: Zamak
 Environmental Information:
 - Fully Recyclable
 - Meets RoHS Standards
 ADA Compliant: Yes

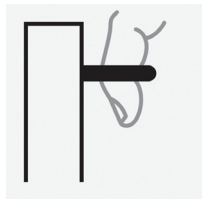

Schwinn Item 2Z395/64 Pull

73 x 9 x 29 mm C/C 64 mm; M4 Thread	
Matte Black	\$10.00
Order Nr. 59184	
Matte Gold	\$11.00
Order Nr. 59183	
Satin Nickel	\$10.00
Order Nr. 59182	
Dark Bronze	\$11.00
Order Nr. 59185	

Schwinn Item 2Z395/160 Pull

169 x 9 x 29 mm C/C 160 mm; M4 Thread	
Matte Black	\$16.00
Order Nr. 59188	
Matte Gold	\$17.00
Order Nr. 59187	
Satin Nickel	\$16.00
Order Nr. 59186	
Dark Bronze	\$17.00
Order Nr. 59189	

Schwinn Item 2Z395/320 Pull

329 x 9 x 29 mm C/C 320 mm; M6 Thread	
Matte Black	\$24.00
Order Nr. 59192	
Matte Gold	\$26.00
Order Nr. 59191	
Satin Nickel	\$24.00
Order Nr. 59190	
Dark Bronze	\$26.00
Order Nr. 59193	

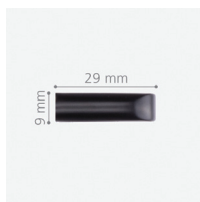

Available Sizes



Available Finishes



Schwinn 2Z240 Series

Material: Zamak

Environmental Information:

- Fully Recyclable

- Meets RoHS Standards

ADA Compliant: Yes

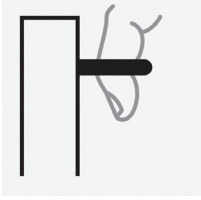

Schwinn Item 2Z240/128 Pull

141 x 12 x 32 mm

C/C 128 mm; M4 Thread

Polished Chrome	\$14.00
-----------------	---------

Order Nr. 59147

Satin Nickel	\$14.00
--------------	---------

Order Nr. 59148

Dark Nickel	\$14.00
-------------	---------

Order Nr. 59149

Schwinn Item 2Z240/160 Pull

173 x 12 x 32 mm

C/C 160 mm; M4 Thread

Polished Chrome	\$16.00
-----------------	---------

Order Nr. 53760

Satin Nickel	\$16.00
--------------	---------

Order Nr. 59150

Dark Nickel	\$16.00
-------------	---------

Order Nr. 59151

Schwinn Item 2Z240/320 Pull

333 x 12 x 32 mm

C/C 320 mm; M4 Thread

Polished Chrome	\$24.00
-----------------	---------

Order Nr. 53757

Satin Nickel	\$24.00
--------------	---------

Order Nr. 59152

Dark Nickel	\$24.00
-------------	---------

Order Nr. 59153

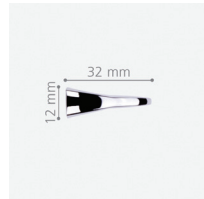
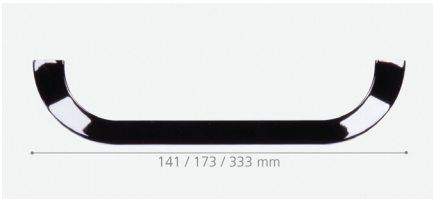

Available Sizes



Available Finishes



Schwinn 22930 Series

Material: Zamak
 Environmental Information:
 - Fully Recyclable
 - Meets RoHS Standards
 ADA Compliant: Yes

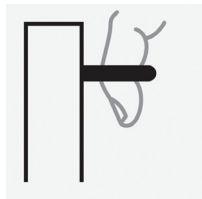

Schwinn Item 22930/96 Pull

120 x 15 x 30 mm
 C/C 96 mm; M4 Thread

Polished Chrome	\$12.00
Order Nr. 59160	
Satin Nickel	\$12.00
Order Nr. 59161	

Schwinn Item 22930/160 Pull

192 x 19 x 32 mm
 C/C 160 mm; M4 Thread

Polished Chrome	\$18.00
Order Nr. 53737	
Satin Nickel	\$18.00
Order Nr. 52358	

Schwinn Item 22930/320 Pull

350 x 19 x 32 mm
 C/C 320 mm; M4 Thread

Polished Chrome	\$36.00
Order Nr. 53866	
Satin Nickel	\$36.00
Order Nr. 59125	

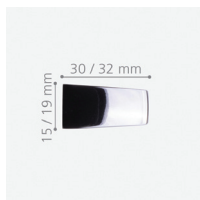
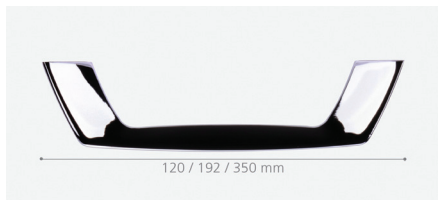

Available Sizes

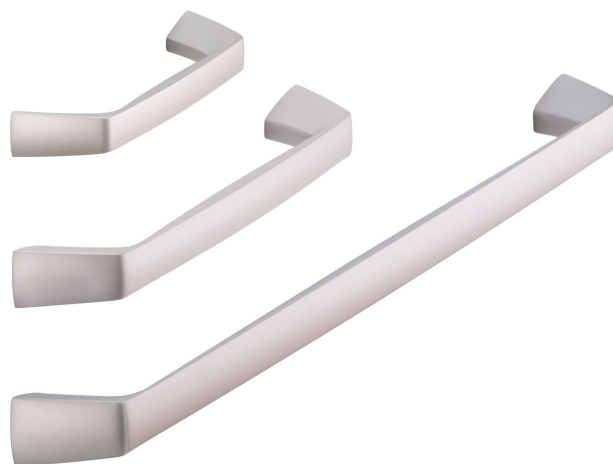

Available Finishes



Schwinn 33243 Series

Material: Stainless Steel Grade 303

Environmental Information:

- Fully Recyclable
 - Meets RoHS Standards
- ADA Compliant: Yes

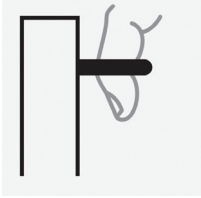

Schwinn Item 33243/128 Pull

140 x 12 x 36 mm

C/C 128 mm; M4 Thread

Brushed Stainless Steel \$14.00
Order Nr. 51473

Schwinn Item 33243/160 Pull

172 x 12 x 36 mm

C/C 160 mm; M4 Thread

Brushed Stainless Steel \$15.00
Order Nr. 51474

Schwinn Item 33243/192 Pull

204 x 12 x 36 mm

C/C 192 mm; M4 Thread

Brushed Stainless Steel \$17.00
Order Nr. 51475

Schwinn Item 33243/256 Pull

268 x 12 x 36 mm

C/C 256 mm; M4 Thread

Brushed Stainless Steel \$18.00
Order Nr. 51477

Schwinn Item 33243/320 Pull

332 x 12 x 36 mm

C/C 320 mm; M4 Thread

Brushed Stainless Steel \$20.00
Order Nr. 51479

Schwinn Item 33243/480 Pull

492 x 12 x 36 mm

C/C 480 mm; M4 Thread

Brushed Stainless Steel \$24.00
Order Nr. 51482

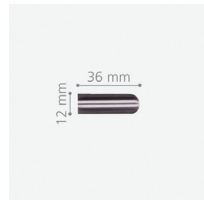
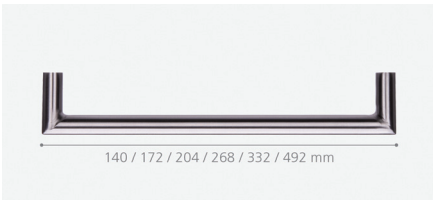
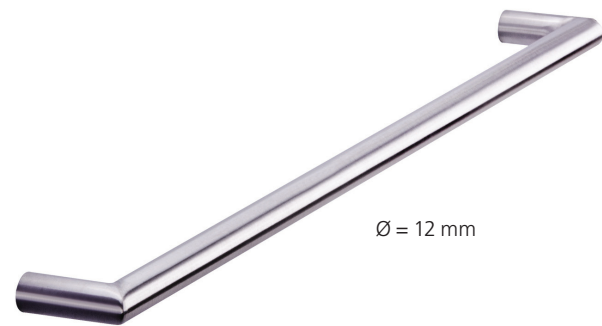

Schwinn 44588 Series

Material: Stainless Steel Grade 303

Environmental Information:

- Fully Recyclable
- Meets RoHS Standards

ADA Compliant: Yes

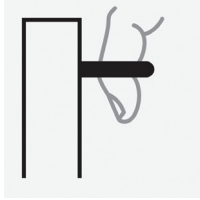

Schwinn Item 44588/320 Pull

334 x 14 x 36 mm

C/C 320 mm; M6 Thread; Appliance Pull

Brushed Stainless Steel

\$46.00

Order Nr. 59113

Schwinn Item 44588/480 Pull

494 x 14 x 36 mm

C/C 480 mm; M6 Thread; Appliance Pull

Brushed Stainless Steel

\$65.00

Order Nr. 59114

Schwinn Item 44588/736 Pull

750 x 14 x 36 mm

C/C 736 mm; M6 Thread; Appliance Pull

Brushed Stainless Steel

\$98.00

Order Nr. 59115

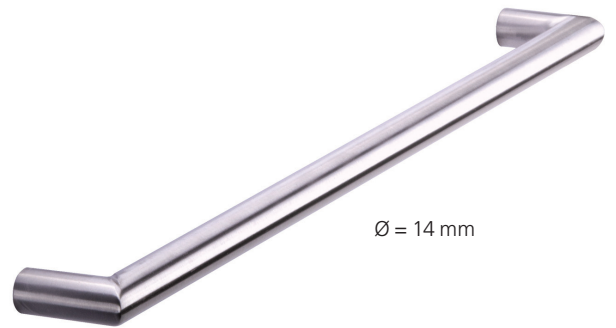
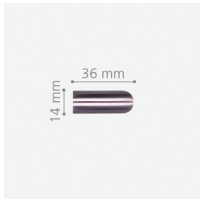
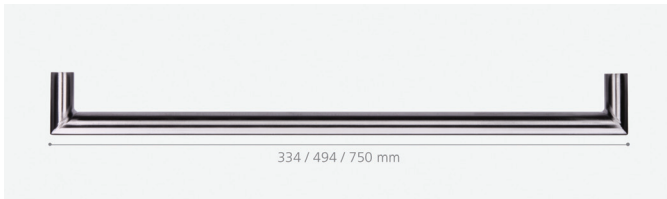

Schwinn 44135 Series

Material: Stainless Steel Grade 303

Environmental Information:

- Fully Recyclable
 - Meets RoHS Standards
- ADA Compliant: Yes

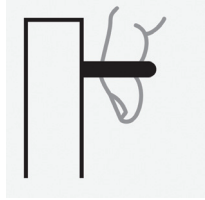

Schwinn Item 44135/128 Pull

150 x 12 x 34 mm

C/C 128 mm; M4 Thread

Brushed Stainless Steel

\$14.00

Order Nr. 51984

Schwinn Item 44135/160 Pull

182 x 12 x 34 mm

C/C 160 mm; M4 Thread

Brushed Stainless Steel

\$15.00

Order Nr. 51985

Schwinn Item 44135/192 Pull

214 x 12 x 34 mm

C/C 192 mm; M4 Thread

Brushed Stainless Steel

\$16.00

Order Nr. 51986

Schwinn Item 44135/256 Pull

278 x 12 x 34 mm

C/C 256 mm; M4 Thread

Brushed Stainless Steel

\$17.00

Order Nr. 51988

Schwinn Item 44135/320 Pull

342 x 12 x 34 mm

C/C 320 mm; M4 Thread

Brushed Stainless Steel

\$20.00

Order Nr. 51990

Schwinn Item 44135/480 Pull

502 x 12 x 34 mm

C/C 480 mm; M4 Thread

Brushed Stainless Steel

\$24.00

Order Nr. 51993

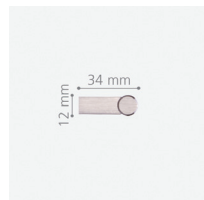
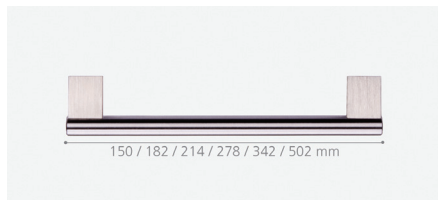
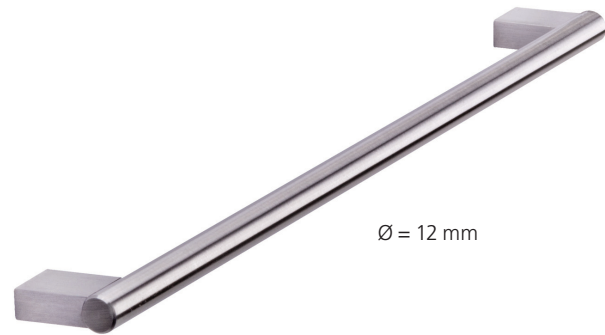

Schwinn 44587 Series

Material: Stainless Steel Grade 303

Environmental Information:

- Fully Recyclable
- Meets RoHS Standards

ADA Compliant: Yes

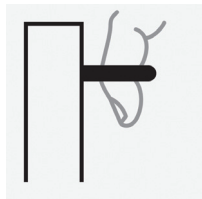

Schwinn Item 44587/320 Pull

342 x 14 x 37 mm

C/C 320 mm; M6 Thread; Appliance Pull

Brushed Stainless Steel

\$46.00

Order Nr. 59116

Schwinn Item 44587/480 Pull

502 x 14 x 37 mm

C/C 480 mm; M6 Thread; Appliance Pull

Brushed Stainless Steel

\$66.00

Order Nr. 59117

Schwinn Item 44587/736 Pull

758 x 14 x 37 mm

C/C 736 mm; M6 Thread; Appliance Pull

Brushed Stainless Steel

\$99.00

Order Nr. 59118

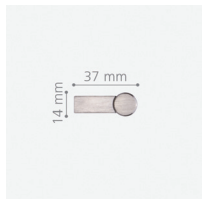
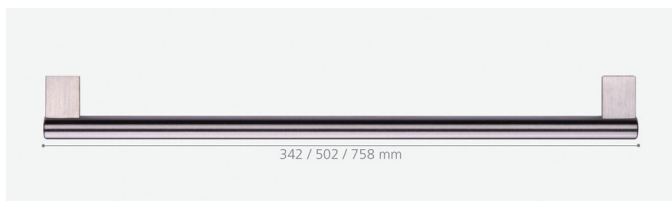
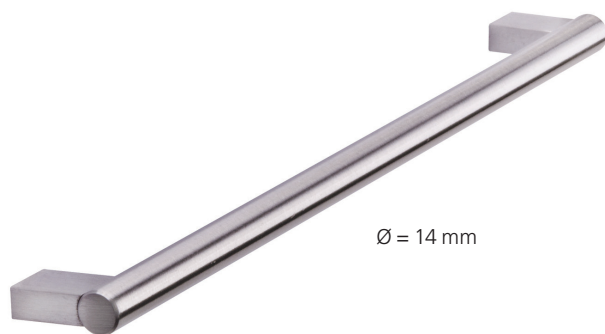

Schwinn 33289 Series

Material: Stainless Steel Grade 303

Environmental Information:

- Fully Recyclable
 - Meets RoHS Standards
- ADA Compliant: Yes

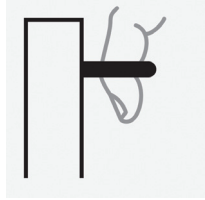

Schwinn Item 33289/128 Pull

168 x 12 x 35 mm

C/C 128 mm; M4 Thread

Brushed Stainless Steel

\$11.00

Order Nr. 52242

Schwinn Item 33289/160 Pull

200 x 12 x 35 mm

C/C 160 mm; M4 Thread

Brushed Stainless Steel

\$12.00

Order Nr. 52243

Schwinn Item 33289/192 Pull

232 x 12 x 35 mm

C/C 192 mm; M4 Thread

Brushed Stainless Steel

\$13.00

Order Nr. 52244

Schwinn Item 33289/256 Pull

296 x 12 x 35 mm

C/C 256 mm; M4 Thread

Brushed Stainless Steel

\$14.00

Order Nr. 52246

Schwinn Item 33289/320 Pull

360 x 12 x 35 mm

C/C 320 mm; M4 Thread

Brushed Stainless Steel

\$16.00

Order Nr. 52248

Schwinn Item 33289/480 Pull

520 x 12 x 35 mm

C/C 480 mm; M4 Thread

Brushed Stainless Steel

\$20.00

Order Nr. 52251

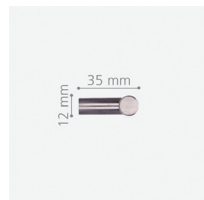
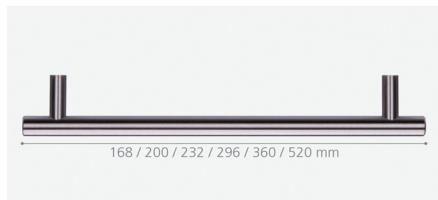

Schwinn 33343 Series

Material: Stainless Steel Grade 303
Environmental Information:
- Fully Recyclable
- Meets RoHS Standards
ADA Compliant: Yes

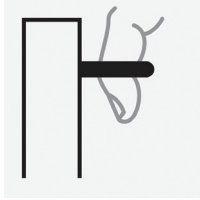

Schwinn item 33343/128 Pull

144 x 16 x 40 mm

C/C 128 mm; M4 Thread

Brushed Stainless Steel

\$19.00

Order Nr. 52313

Schwinn Item 33343/192 Pull

208 x 16 x 40 mm

C/C 192 mm; M4 Thread

Brushed Stainless Steel

\$21.00

Order Nr. 52315

Schwinn Item 33343/256 Pull

272 x 16 x 40 mm

C/C 256 mm; M6 Thread; Appliance Pull

Brushed Stainless Steel

\$25.00

Order Nr. 59119

Schwinn Item 33343/448 Pull

464 x 16 x 40 mm

C/C 448 mm; M6 Thread; Appliance Pull

Brushed Stainless Steel

\$45.00

Order Nr. 59120

Schwinn Item 33343/736 Pull

752 x 16 x 40 mm

C/C 736 mm; M6 Thread; Appliance Pull

Brushed Stainless Steel

\$69.00

Order Nr. 59121

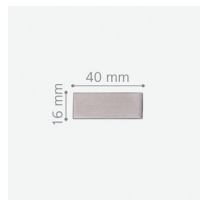
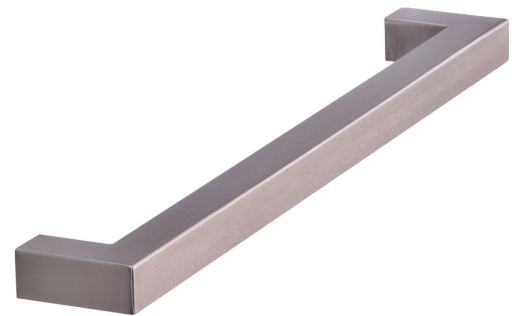

Schwinn 33958 Series

Material: Stainless Steel Grade 303

Environmental Information:

- Fully Recyclable
 - Meets RoHS Standards
- ADA Compliant: Yes

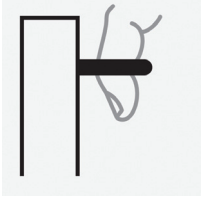

Schwinn Item 33958/128 Pull

150 x 12 x 34 mm

C/C 128 mm; M4 Thread

Knurled Stainless Steel

\$18.00

Order Nr. 54350

Schwinn Item 33958/160 Pull

182 x 12 x 34 mm

C/C 160 mm; M4 Thread

Knurled Stainless Steel

\$19.00

Order Nr. 54351

Schwinn Item 33958/192 Pull

214 x 12 x 34 mm

C/C 192 mm; M4 Thread

Knurled Stainless Steel

\$21.00

Order Nr. 54352

Schwinn Item 33958/256 Pull

278 x 12 x 34 mm

C/C 256 mm; M4 Thread

Knurled Stainless Steel

\$24.00

Order Nr. 59400

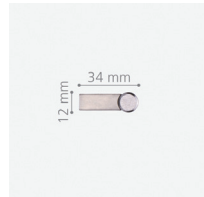
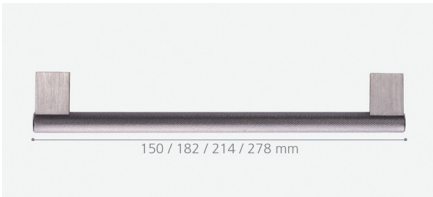
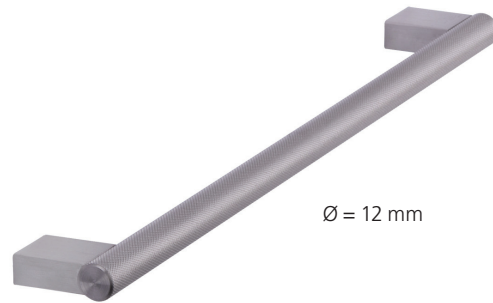

Schwinn 33956 Series

Material: Stainless Steel Grade 303

Environmental Information:

- Fully Recyclable
- Meets RoHS Standards

ADA Compliant: Yes

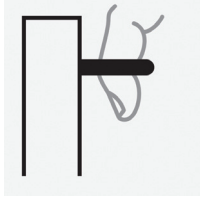

Schwinn Item 33956/320 Pull

342 x 14 x 37 mm

C/C 320 mm; M6 Thread; Appliance Pull

Knurled Stainless Steel

\$52.00

Order Nr. 59401

Schwinn Item 33956/480 Pull

502 x 14 x 37 mm

C/C 480 mm; M6 Thread; Appliance Pull

Knurled Stainless Steel

\$69.00

Order Nr. 59402

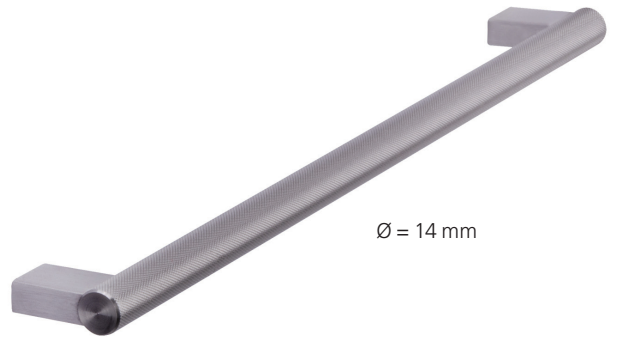
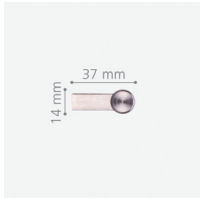

Schwinn 33998 Series

Material: Stainless Steel Grade 303, Aluminum

Environmental Information:

- Fully Recyclable
 - Meets RoHS Standards
- ADA Compliant: Yes

Schwinn Item 33998 Knob

40 x 12 x 35 mm

C/C 0; M4 Thread

Knurled Stainless Steel \$14.00

Order Nr. 59405

Knurled Matte Black \$14.00

Order Nr. 59216

Knurled Matte Gold \$14.00

Order Nr. 59215

Knurled Dark Bronze \$14.00

Order Nr. 59217

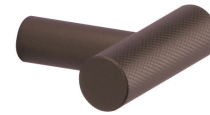
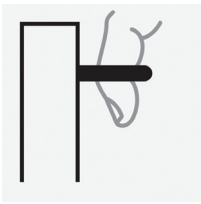

Schwinn Item 33998/64 Pull

104 x 12 x 35 mm

C/C 64 mm; M4 Thread

Knurled Matte Black \$16.00

Order Nr. 59219

Knurled Matte Gold \$16.00

Order Nr. 59218

Knurled Dark Bronze \$16.00

Order Nr. 59220

Schwinn Item 33998/128 Pull

168 x 12 x 35 mm

C/C 128 mm; M4 Thread

Knurled Matte Black \$18.00

Order Nr. 59222

Knurled Matte Gold \$18.00

Order Nr. 59221

Knurled Dark Bronze \$18.00

Order Nr. 59223

Schwinn Item 33998/160 Pull

200 x 12 x 35 mm

C/C 160 mm; M4 Thread

Knurled Matte Black \$20.00

Order Nr. 59225

Knurled Matte Gold \$20.00

Order Nr. 59224

Knurled Dark Bronze \$20.00

Order Nr. 59226

Schwinn Item 33998/256 Pull

296 x 12 x 35 mm

C/C 256 mm; M5 Thread

Knurled Matte Black \$30.00

Order Nr. 59228

Knurled Matte Gold \$30.00

Order Nr. 59227

Knurled Dark Bronze \$30.00

Order Nr. 59229



Available Sizes

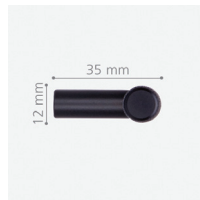
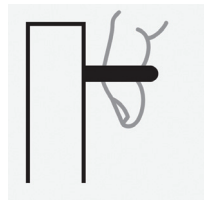

Available Finishes



Schwinn 44702 Series

Material: Aluminum/Zamak
 Environmental Information:
 - Fully Recyclable
 - Meets RoHS Standards
 ADA Compliant: Yes

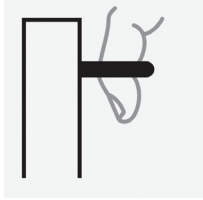

Schwinn Item 44702/64 Pull

80 x 16 x 40 mm

C/C 64 mm; M4 Thread

Knurled Matte Black	\$14.00
---------------------	---------

Order Nr. 59194

Knurled Matte Gold	\$14.00
--------------------	---------

Order Nr. 59196

Knurled Dark Bronze	\$14.00
---------------------	---------

Order Nr. 59195

Schwinn Item 44702/128 Pull

144 x 16 x 40 mm

C/C 128 mm; M4 Thread

Knurled Matte Black	\$18.00
---------------------	---------

Order Nr. 59197

Knurled Matte Gold	\$18.00
--------------------	---------

Order Nr. 59199

Knurled Dark Bronze	\$18.00
---------------------	---------

Order Nr. 59198

Schwinn Item 44702/160 Pull

176 x 16 x 40 mm

C/C 160 mm; M4 Thread

Knurled Matte Black	\$22.00
---------------------	---------

Order Nr. 59200

Knurled Matte Gold	\$22.00
--------------------	---------

Order Nr. 59202

Knurled Dark Bronze	\$22.00
---------------------	---------

Order Nr. 59201

Schwinn Item 44702/256 Pull

272 x 16 x 40 mm

C/C 256 mm; M5 Thread

Knurled Matte Black	\$26.00
---------------------	---------

Order Nr. 59203

Knurled Matte Gold	\$26.00
--------------------	---------

Order Nr. 59205

Knurled Dark Bronze	\$26.00
---------------------	---------

Order Nr. 59204

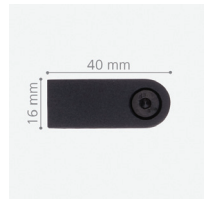
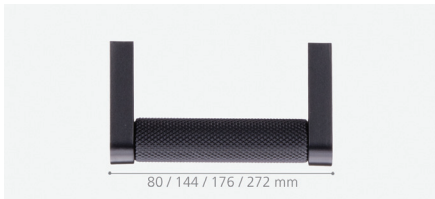

Available Sizes

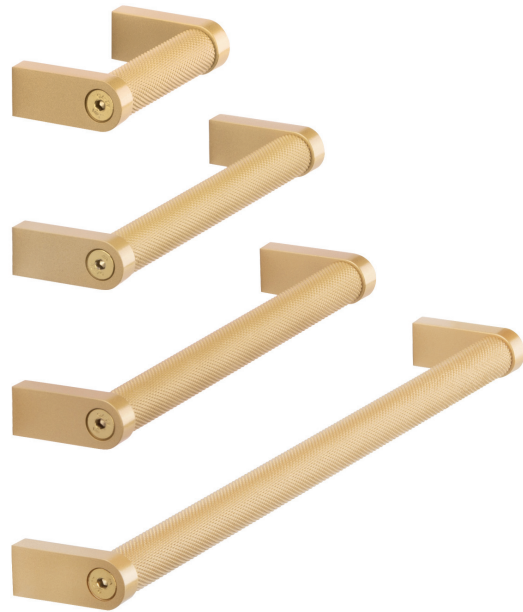

Available Finishes



Schwinn 33132 Series

Material: Stainless Steel Grade 303

Environmental Information:

- Fully Recyclable

- Meets RoHS Standards

ADA Compliant: Yes for C/C 192mm +

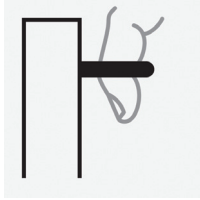

Schwinn Item 33132/96 Pull

119 x 10 x 31 mm

C/C 96 mm; M4 Thread

Brushed Stainless Steel

\$7.00

Order Nr. 50009

Schwinn Item 33132/128 Pull

155 x 10 x 31 mm

C/C 128 mm; M4 Thread

Brushed Stainless Steel

\$8.00

Order Nr. 50010

Schwinn Item 33132/160 Pull

190 x 10 x 31 mm

C/C 160 mm; M4 Thread

Brushed Stainless Steel

\$9.00

Order Nr. 50011



Schwinn Item 33132/192 Pull

220 x 10 x 31 mm

C/C 192 mm; M4 Thread

Brushed Stainless Steel

\$10.00

Order Nr. 50012



Schwinn 2Z045 Series

Material: Zamak

Environmental Information:

- Fully Recyclable
 - Meets RoHS Standards
- ADA Compliant: No



Schwinn Item 2Z045/64 Pull

118 x 8 x 23 mm

C/C 64 mm; M4 Thread

Polished Chrome \$21.00

Order Nr. 53203

Matte Black \$19.00

Order Nr. 59421

Matte Gold \$19.00

Order Nr. 59422

Satin Nickel \$18.00

Order Nr. 53205

Schwinn Item 2Z045/160 Pull

234 x 8 x 23 mm

C/C 160 mm; M4 Thread

Polished Chrome \$22.00

Order Nr. 53206

Matte Black \$21.00

Order Nr. 59423

Matte Gold \$21.00

Order Nr. 59424

Satin Nickel \$21.00

Order Nr. 53208

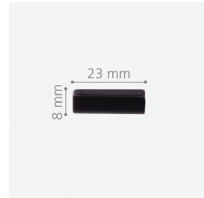
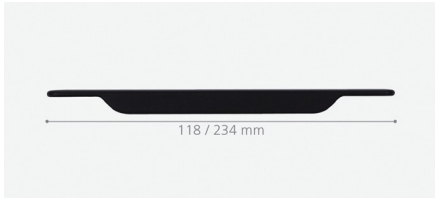

Available Sizes



Available Finishes



Schwinn 33756 Series

Material: Aluminum
 Environmental Information:
 - Fully Recyclable
 - Meets RoHS Standards
 ADA Compliant: No

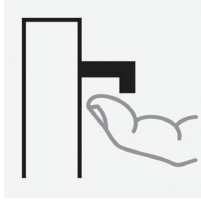

Schwinn Item 33756/64 Pull

84 x 20 x 20 mm

C/C 64 mm; M4 Thread

Clear Anodized	\$10.00
Order Nr. 53218	
Polished Chrome	\$11.00
Order Nr. 59085	
Matte Black	\$11.00
Order Nr. 59353	
Matte Gold	\$12.00
Order Nr. 59351	

Schwinn Item 33756/192 Pull

212 x 20 x 20 mm

C/C 192 mm; M4 Thread

Clear Anodized	\$19.00
Order Nr. 53220	
Polished Chrome	\$20.00
Order Nr. 59086	
Matte Black	\$20.00
Order Nr. 59354	
Matte Gold	\$21.00
Order Nr. 59352	

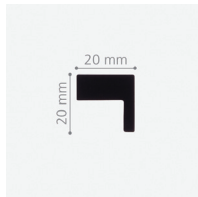
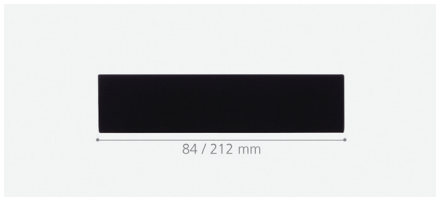

Available Sizes

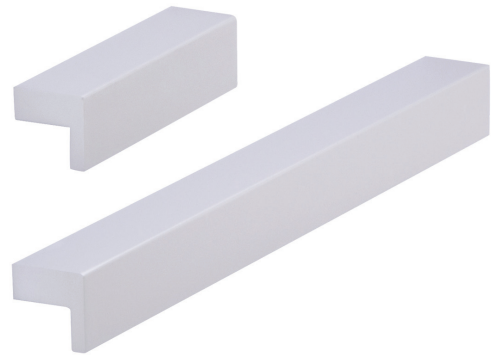

Available Finishes



Schwinn 34096 Series

Material: Aluminum

Environmental Information:

- Fully Recyclable

- Meets RoHS Standards

ADA Compliant: No



Schwinn 34096/64 Pull

84 x 20 x 24 mm

C/C 64 mm; M4 Thread

Polished Chrome	\$12.00
-----------------	---------

Order Nr. 59460

Matte Black	\$12.00
-------------	---------

Order Nr. 59463

Matte White	\$12.00
-------------	---------

Order Nr. 59464

Matte Gold	\$14.00
------------	---------

Order Nr. 59462

Satin Nickel	\$12.00
--------------	---------

Order Nr. 59461

Schwinn 34096/160 Pull

180 x 20 x 24 mm

C/C 160 mm; M4 Thread

Polished Chrome	\$18.00
-----------------	---------

Order Nr. 59465

Matte Black	\$18.00
-------------	---------

Order Nr. 59468

Matte White	\$18.00
-------------	---------

Order Nr. 59469

Matte Gold	\$20.00
------------	---------

Order Nr. 59467

Satin Nickel	\$18.00
--------------	---------

Order Nr. 59466

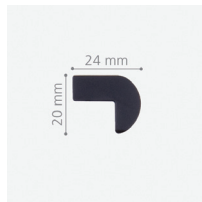

Available Sizes



Available Finishes



Schwinn 34097 Series

Material: Aluminum
 Environmental Information:
 - Fully Recyclable
 - Meets RoHS Standards
 ADA Compliant: No

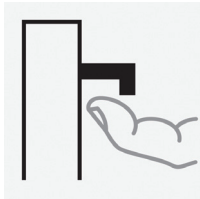

Schwinn 34097/64 Pull

84 x 20 x 20 mm

C/C 64 mm; M4 Thread

Polished Chrome	\$12.00
Order Nr. 59470	
Matte Black	\$12.00
Order Nr. 59473	
Matte White	\$12.00
Order Nr. 59474	
Matte Gold	\$14.00
Order Nr. 59472	
Satin Nickel	\$12.00
Order Nr. 59471	

Schwinn 34097/160 Pull

180 x 20 x 20 mm

C/C 160 mm; M4 Thread

Polished Chrome	\$18.00
Order Nr. 59475	
Matte Black	\$18.00
Order Nr. 59478	
Matte White	\$18.00
Order Nr. 59479	
Matte Gold	\$20.00
Order Nr. 59477	
Satin Nickel	\$18.00
Order Nr. 59476	

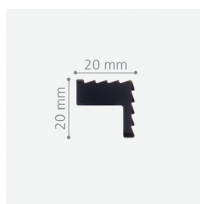

Available Sizes



Available Finishes



Schwinn 22891 Series

Material: Zamak

Environmental Information:

- Fully Recyclable

- Meets RoHS Standards

ADA Compliant: No

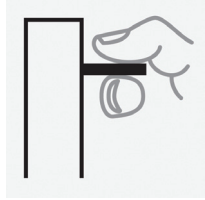

Schwinn Item 22891/64 Pull

75 x 9 x 20 mm

C/C 64 mm; M4 Thread

Polished Chrome	\$15.00
Order Nr. 53214	
Matte Black	\$14.00
Order Nr. 59348	
Matte Gold	\$14.00
Order Nr. 59425	
Satin Nickel	\$14.00
Order Nr. 53213	
Satin Nickel Performance Finish	\$15.00
Order Nr. 59055	
Dark Bronze	\$14.00
Order Nr. 59426	

Schwinn Item 22891/128 Pull

140 x 9 x 20 mm

C/C 128 mm; M4 Thread

Polished Chrome	\$18.00
Order Nr. 52519	
Matte Black	\$17.00
Order Nr. 59349	
Matte Gold	\$18.00
Order Nr. 59427	
Satin Nickel	\$17.00
Order Nr. 52518	
Satin Nickel Performance Finish	\$18.00
Order Nr. 59056	
Dark Bronze	\$18.00
Order Nr. 59428	

Schwinn Item 22891/192 Pull

202 x 9 x 20 mm

C/C 192 mm; M4 Thread

Polished Chrome	\$23.00
Order Nr. 53217	
Matte Black	\$22.00
Order Nr. 59350	
Matte Gold	\$22.00
Order Nr. 59429	
Satin Nickel	\$22.00
Order Nr. 53216	
Satin Nickel Performance Finish	\$23.00
Order Nr. 59057	
Dark Bronze	\$22.00
Order Nr. 59430	

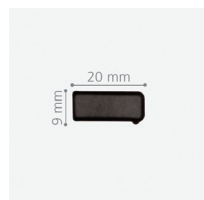
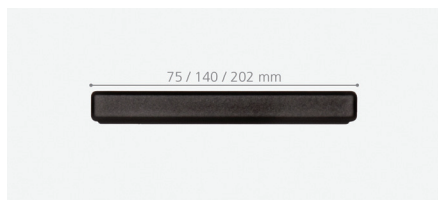

Available Sizes

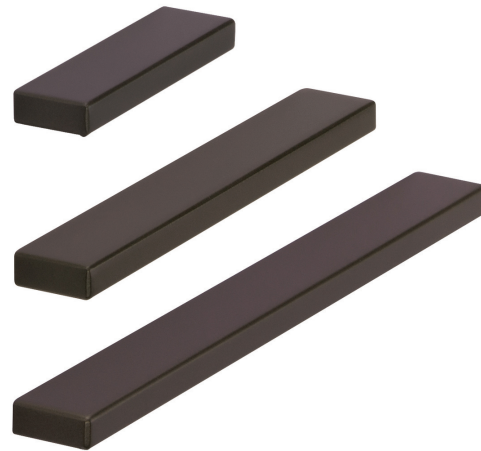

Available Finishes

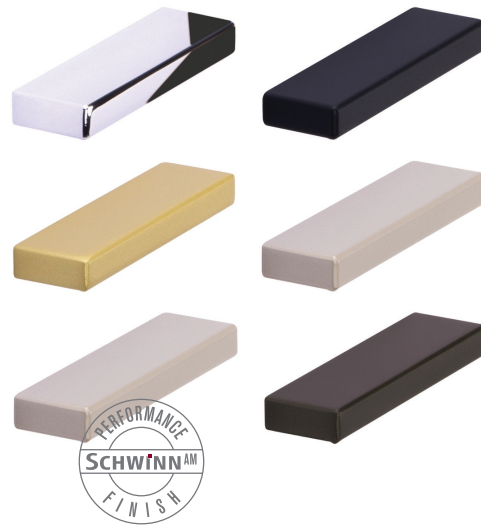

Schwinn 44537 Series

Material: Stainless Steel/Glass
Environmental Information:
- Fully Recyclable
- Meets RoHS Standards
ADA Compliant: Yes

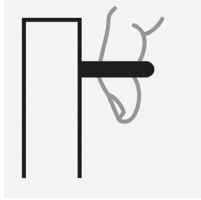

Schwinn Item 44537/128 Pull

202 x 18 x 40 mm

C/C 128 mm; M4 Thread

Brushed Stainless Steel, Clear

\$40.00

Order Nr. 51515

Schwinn Item 44537/192 Pull

265 x 18 x 40

C/C 192 mm; M4 Thread

Brushed Stainless Steel, Clear

\$46.00

Order Nr. 59404

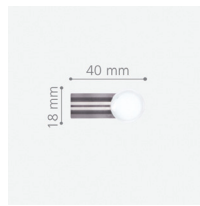
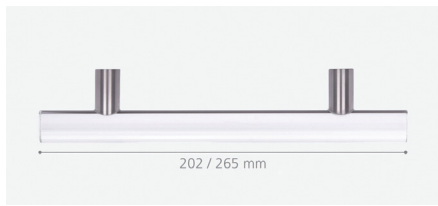

Schwinn Item 44452 Knob

Material: Stainless Steel/Glass

Environmental Information:

- Fully Recyclable
- Meets RoHS Standards

ADA Compliant: No

30 x 42 mm

C/C 0; M4 Thread

Brushed Stainless Steel, Clear

\$18.00

Order Nr. 51948

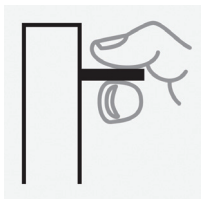

Schwinn Item 2Z326/160 Pull

Material: Zamak/Leather

Environmental Information:

- Fully Recyclable
 - Meets RoHS Standards
- ADA Compliant: Yes

212 x 30 x 24 mm, M4 Thread

C/C 160mm, M4 Thread

Polished Chrome/Black Leather \$17.00

Order Nr. 59389

Matte Black/Black Leather \$16.00

Order Nr. 59388

Satin Nickel/Brown Leather \$17.00

Order Nr. 59390

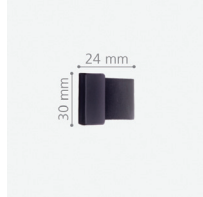
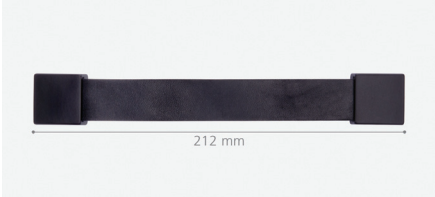
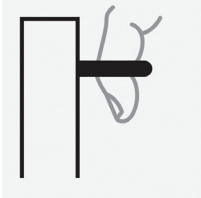

Schwinn Item 2Z221/16 Pull

Material: Zamak/Leather
Environmental Information:
- Fully Recyclable
- Meets RoHS Standards
ADA Compliant: Yes

26 x 11 x 71 mm, M4 Thread
C/C 16mm

Polished Chrome/Black Leather	\$14.00
Order Nr. 54401	
Matte Black/Black Leather	\$13.00
Order Nr. 59386	
Satin Nickel/Brown Leather	\$14.00
Order Nr. 59387	

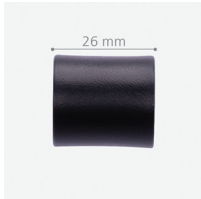
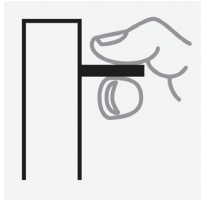

Schwinn Item 22075 Covered Flush Pull

Material: Zamak

Environmental Information:

- Fully Recyclable
 - Meets RoHS Standards
- ADA Compliant: No

140 x 60 x 3 mm

120 x 47 x 16 mm

C/C 128 mm; M4 Thread

Polished Chrome \$34.00

Order Nr. 53355

Satin Nickel \$36.00

Order Nr. 59009

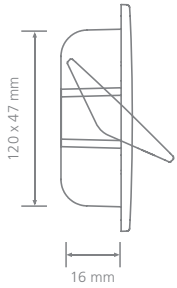

Schwinn Item 22518 Recessed Edge Pull

Material: Zamak

Environmental Information:

- Fully Recyclable
 - Meets RoHS Standards
- ADA Compliant: No

138 x 30 x 16 mm

134 x 27 x 12 mm

C/C 128 mm; M4 Thread

Polished Chrome \$20.00

Order Nr. 52682

Matte Black \$19.00

Order Nr. 59345

Satin Nickel \$19.00

Order Nr. 52288

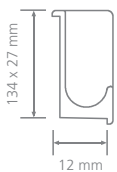

Schwinn Item 2Z078 Flush Pull

Material: Zamak

Environmental Information:

- Fully Recyclable
 - Meets RoHS Standards
- ADA Compliant: No

106 x 37 x 2 mm

103 x 34 x 17 mm

C/C 96 mm; M4 Thread

Polished Chrome \$29.00

Order Nr. 53358

Matte Black \$29.00

Order Nr. 59346

Satin Nickel \$29.00

Order Nr. 53360

Satin Nickel Performance Finish \$30.00

Order Nr. 59058

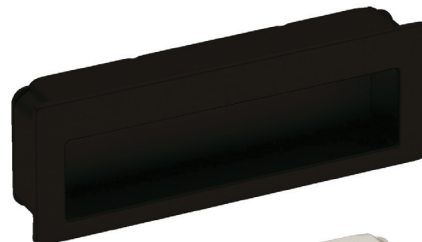
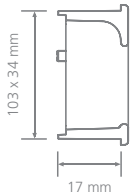
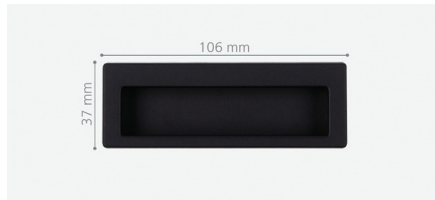

Schwinn 33793 Series

Material: Aluminum

Environmental Information:

- Fully Recyclable
 - Meets RoHS Standards
- ADA Compliant: No

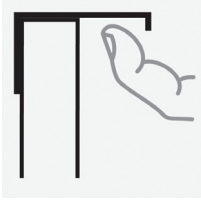

Schwinn Item 33793/32 Tab Pull

52 x 20 x 36 mm (1.8 mm Thickness)

C/C 32 mm; #6 Wood Screw

Polished Chrome	\$8.00
Order Nr. 59069	
Matte Chrome	\$8.00
Order Nr. 59070	
Matte Black	\$8.00
Order Nr. 59340	
Matte White	\$8.00
Order Nr. 59442	
Matte Gold	\$9.00
Order Nr. 59337	
Polished Nickel	\$8.00
Order Nr. 59071	
Satin Nickel	\$8.00
Order Nr. 59068	

Schwinn Item 33793/96 Tab Pull

116 x 20 x 36 mm (1.8 mm Thickness)

C/C 96 mm; #6 Wood Screw

Polished Chrome	\$12.00
Order Nr. 59444	
Matte Chrome	\$12.00
Order Nr. 59445	
Matte Black	\$12.00
Order Nr. 59448	
Matte White	\$12.00
Order Nr. 59449	
Matte Gold	\$14.00
Order Nr. 59447	
Polished Nickel	\$12.00
Order Nr. 59446	
Satin Nickel	\$12.00
Order Nr. 59443	

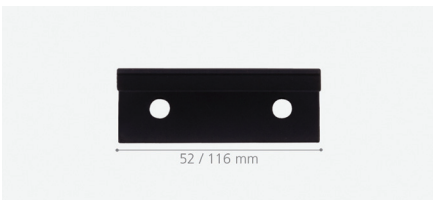

Available Sizes

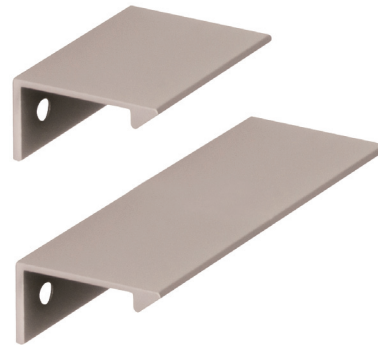

Available Finishes

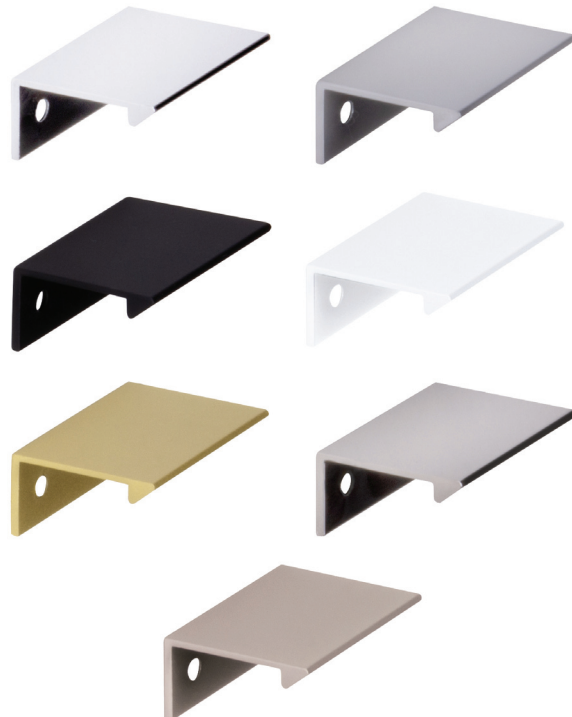

Schwinn Item Z2204/160 Edge Pull

Material: Zamak

Environmental Information:

- Fully Recyclable
 - Meets RoHS Standards
- ADA Compliant: Yes

179 x 19 x 43 mm (2.0 mm Thickness)

C/C 160 mm; #6 Wood Screw

Polished Chrome \$20.00

Order Nr. 53769

Satin Nickel \$20.00

Order Nr. 59143

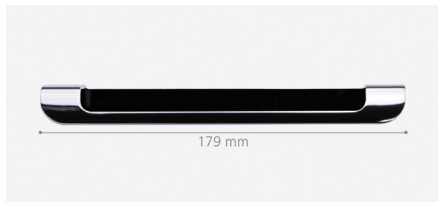

Schwinn Item Z2245/64 Tab Pull

Material: Zamak

Environmental Information:

- Fully Recyclable
 - Meets RoHS Standards
- ADA Compliant: No

80 x 20 x 46 mm (2.0 mm Thickness)

C/C 64; #6 Wood Screw

Polished Chrome \$14.00

Order Nr. 59154

Matte Black \$14.00

Order Nr. 59375

Matte Gold \$14.00

Order Nr. 59376

Satin Nickel \$14.00

Order Nr. 59156

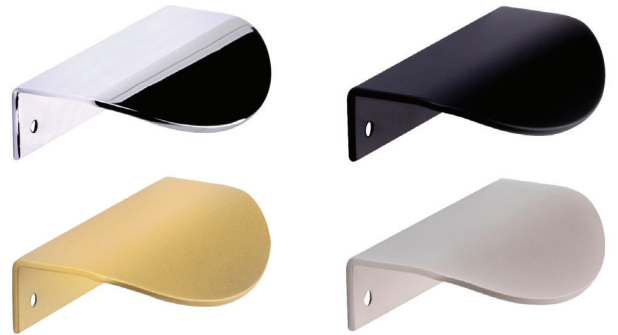
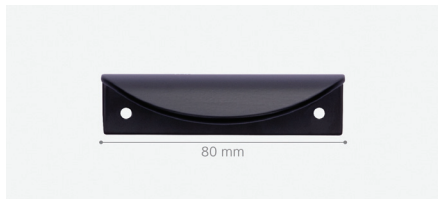

Schwinn 34095 Series

Material: Aluminum

Environmental Information:

- Fully Recyclable
 - Meets RoHS Standards
- ADA Compliant: No

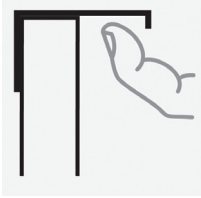

Schwinn 34095/96 Tab Pull

116 x 20 x 39 mm (1.7 mm Thickness)

C/C 96 mm; #6 Wood Screw

Polished Chrome	\$12.00
Order Nr. 59450	
Matte Black	\$12.00
Order Nr. 59453	
Matte White	\$12.00
Order Nr. 59454	
Matte Gold	\$14.00
Order Nr. 59452	
Satin Nickel	\$12.00
Order Nr. 59451	

Schwinn 34095/192 Tab Pull

212 x 20 x 39 mm (1.7 mm Thickness)

C/C 192 mm; #6 Wood Screw

Polished Chrome	\$15.00
Order Nr. 59455	
Matte Black	\$15.00
Order Nr. 59458	
Matte White	\$15.00
Order Nr. 59459	
Matte Gold	\$17.00
Order Nr. 59457	
Satin Nickel	\$15.00
Order Nr. 59456	

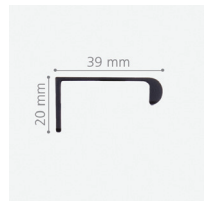

Available Sizes



Available Finishes



Schwinn 33651 Series

Material: Steel
 Environmental Information:
 - Fully Recyclable
 - Meets RoHS Standards
 ADA Compliant: No

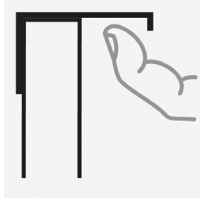

Schwinn Item 33651/32 Tab Pull

65 x 21 x 45 mm (1.5 mm Thickness)

C/C 32; #6 Wood Screw

Matte Black \$12.00

Order Nr. 59230

Matte Gold \$12.00

Order Nr. 59231

Satin Nickel \$12.00

Order Nr. 59232

Schwinn Item 33651/160 Tab Pull

188 x 21 x 45 mm (1.5 mm Thickness)

C/C 160; #6 Wood Screw

Matte Black \$16.00

Order Nr. 59233

Matte Gold \$16.00

Order Nr. 59234

Satin Nickel \$16.00

Order Nr. 59407

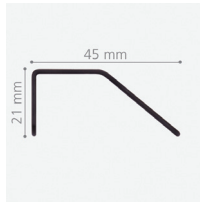
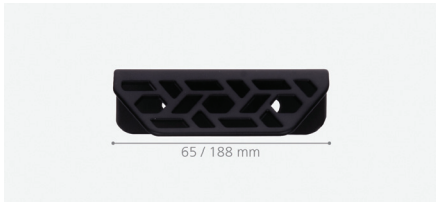

Available Sizes



Available Finishes



Schwinn 33766 Series

Material: Aluminum

Environmental Information:

- Fully Recyclable

- Meets RoHS Standards

ADA Compliant: No

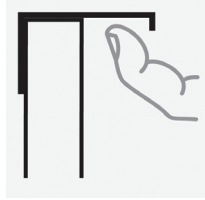

Schwinn Item 33766/96 Tab Pull

224 x 19.5 x 38 mm (1.3 mm Thickness)

C/C 96 mm; #6 Wood Screw

Clear Anodized	\$11.00
Order Nr. 59299	
Nickel Color	\$12.00
Order Nr. 59307	
Dark Bronze Color	\$12.00
Order Nr. 59315	
Matte Black	\$12.00
Order Nr. 59323	
Polished Chrome	\$13.00
Order Nr. 59003	

Schwinn Item 33766/160 Tab Pull

300 x 19.5 x 38 mm (1.3 mm Thickness)

C/C 160 mm; #6 Wood Screw

Clear Anodized	\$15.00
Order Nr. 59300	
Nickel Color	\$16.00
Order Nr. 59308	
Dark Bronze Color	\$16.00
Order Nr. 59316	
Matte Black	\$16.00
Order Nr. 59324	
Polished Chrome	\$17.00
Order Nr. 59004	

Schwinn Item 33766/256 Tab Pull

376 x 19.5 x 38 mm (1.3 mm Thickness)

C/C 256 mm; #6 Wood Screw

Clear Anodized	\$19.00
Order Nr. 59301	
Nickel Color	\$20.00
Order Nr. 59309	
Dark Bronze Color	\$20.00
Order Nr. 59317	
Matte Black	\$20.00
Order Nr. 59325	
Polished Chrome	\$21.00
Order Nr. 59005	

Schwinn Item 33766/320 Tab Pull

452 x 19.5 x 38 mm (1.3 mm Thickness)

C/C 320 mm; #6 Wood Screw

Clear Anodized	\$25.00
Order Nr. 59302	
Nickel Color	\$26.00
Order Nr. 59310	
Dark Bronze Color	\$26.00
Order Nr. 59318	
Matte Black	\$26.00
Order Nr. 59326	
Polished Chrome	\$27.00
Order Nr. 59006	



Full Length Tab Pulls Sizes

Cabinet Size (in)	Drawer Door (in)	Pull Length (mm)
9	8 7/8	224
12	11 7/8	300
15	14 7/8	376
18	17 7/8	452
21	20 7/8	529
24	23 7/8	605
30	29 7/8	757
36	35 7/8	910

Customization

Schwinn Item 33766 Custom Lengths

Each of the 8 in-stock lengths can be cut to a custom length up to 2 inches shorter than the stock length. Schwinn Item 33766/ XL can be cut to an size between 910 mm and 2.9 meters. Turnaround time for custom lengths orders is 2 business days. A one-time customization charge of \$60.00 applies per order. (Note: Polished Chrome tab pulls cannot be cut to size.)

One-Time Customization Charge	\$60.00
Order Nr. 59331	

Paint Grade

For a fully integrated look, the Schwinn Clear Anodized tab pulls can be installed and finished with the cabinet paint when cabinetry is painted on site.

Schwinn Item 33766/384 Tab Pull

529 x 19.5 x 38 mm (1.3 mm Thickness)

C/C 384 mm; #6 Wood Screw

Clear Anodized	\$29.00
Order Nr. 59303	
Nickel Color	\$30.00
Order Nr. 59311	
Dark Bronze Color	\$30.00
Order Nr. 59319	
Matte Black	\$30.00
Order Nr. 59327	
Polished Chrome	\$32.00
Order Nr. 59441	

Schwinn Item 33766/448 Tab Pull

605 x 19.5 x 38 mm (1.3 mm Thickness)

C/C 448 mm; #6 Wood Screw

Clear Anodized	\$36.00
Order Nr. 59304	
Nickel Color	\$38.00
Order Nr. 59312	
Dark Bronze Color	\$38.00
Order Nr. 59320	
Matte Black	\$38.00
Order Nr. 59328	
Polished Chrome	\$40.00
Order Nr. 59007	

Schwinn Item 33766/576 Tab Pull

757 x 19.5 x 38 mm (1.3 mm Thickness)

C/C 576 mm; #6 Wood Screw

Clear Anodized	\$40.00
Order Nr. 59305	
Nickel Color	\$42.00
Order Nr. 59313	
Dark Bronze Color	\$42.00
Order Nr. 59321	
Matte Black	\$42.00
Order Nr. 59329	
Polished Chrome	\$44.00
Order Nr. 59011	

Schwinn Item 33766/768 Tab Pull

910 x 19.5 x 38 mm (1.3 mm Thickness)

C/C 768 mm; #6 Wood Screw

Clear Anodized	\$50.00
Order Nr. 59306	
Nickel Color	\$52.00
Order Nr. 59314	
Dark Bronze Color	\$52.00
Order Nr. 59322	
Matte Black	\$52.00
Order Nr. 59330	
Polished Chrome	\$54.00
Order Nr. 59012	

For longer applications, use:

Schwinn Item 33766/XL

2.9 meters x 19.5 x 38 mm (1.3 mm Thickness)

C/C - 11x spaced 256 mm apart; #6 Wood Screw

Clear Anodized	\$92.00
Order Nr. 59481	
Nickel Color	\$96.00
Order Nr. 59482	
Dark Bronze Color	\$96.00
Order Nr. 59483	
Matte Black	\$96.00
Order Nr. 59484	



Available Finishes

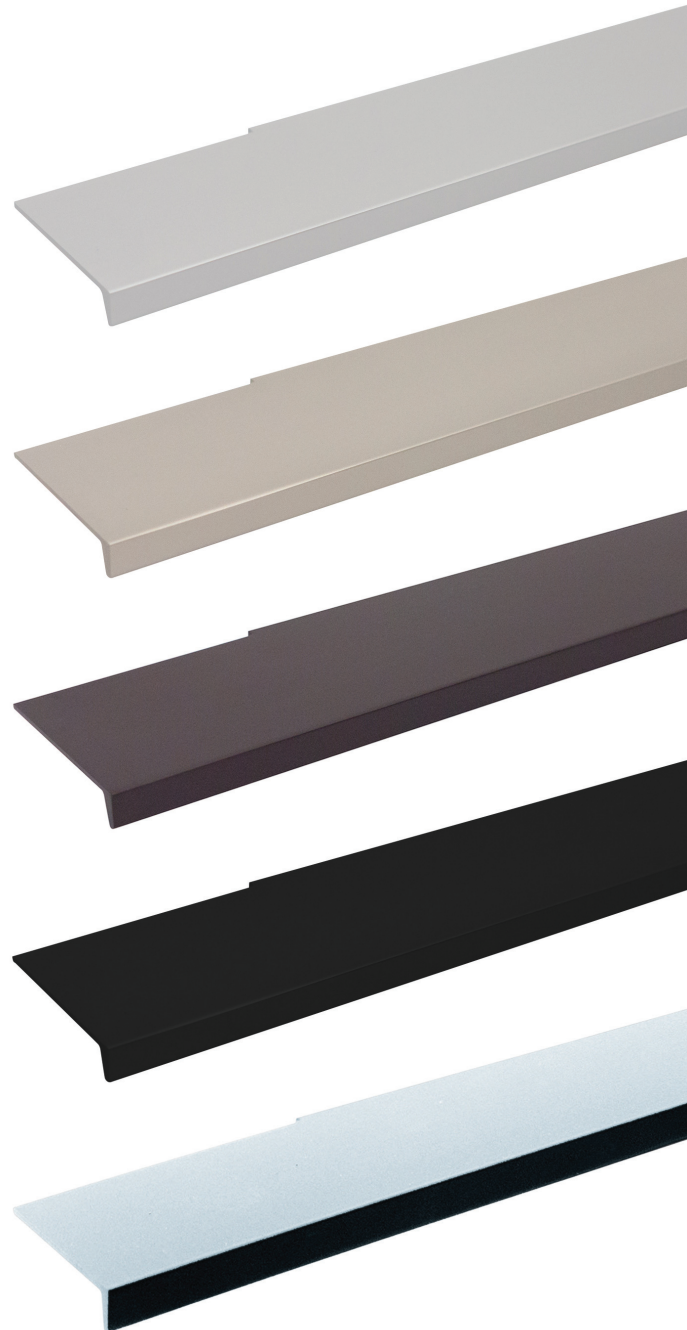

Schwinn 34105 Series

Material: Aluminum

Environmental Information:

- Fully Recyclable

- Meets RoHS Standards

ADA Compliant: No

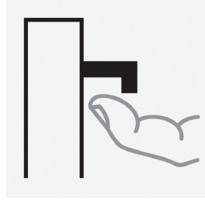

Schwinn Item 34105/160 Pull

224 x 20 x 22 mm

C/C 160 mm; M4 Thread

Clear Anodized \$12.00

Order Nr. 59485

Nickel Color \$14.00

Order Nr. 59486

Matte Black \$14.00

Order Nr. 59488

Polished Chrome \$15.00

Order Nr. 59489

Schwinn Item 34105/224 Pull

300 x 20 x 22 mm

C/C 224 mm; M4 Thread

Clear Anodized \$15.00

Order Nr. 59490

Nickel Color \$16.00

Order Nr. 59491

Matte Black \$16.00

Order Nr. 59493

Polished Chrome \$17.00

Order Nr. 59494

Schwinn Item 34105/288 Pull

376 x 20 x 22 mm

C/C 288 mm; M4 Thread

Clear Anodized \$19.00

Order Nr. 59495

Nickel Color \$20.00

Order Nr. 59496

Matte Black \$20.00

Order Nr. 59498

Polished Chrome \$21.00

Order Nr. 59499

Schwinn Item 34105/384 Pull

452 x 20 x 22 mm

C/C 384 mm; M4 Thread

Clear Anodized \$25.00

Order Nr. 59500

Nickel Color \$26.00

Order Nr. 59501

Matte Black \$26.00

Order Nr. 59503

Polished Chrome \$27.00

Order Nr. 59504

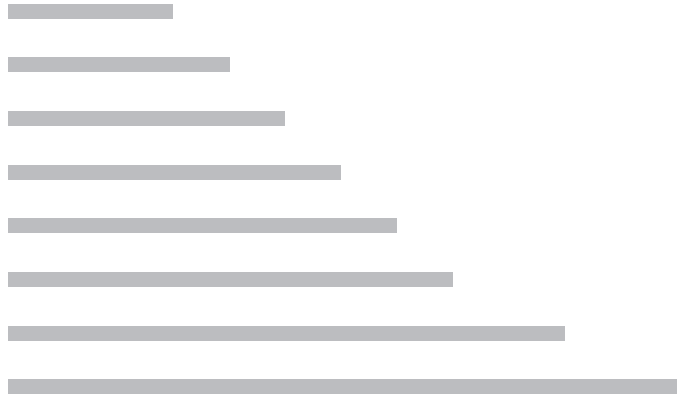

Full Length Tab Pulls Sizes

Cabinet Size (in)	Drawer Door (in)	Pull Length (mm)
9	8 7/8	224
12	11 7/8	300
15	14 7/8	376
18	17 7/8	452
21	20 7/8	529
24	23 7/8	605
30	29 7/8	757
36	35 7/8	910

Customization

Schwinn Item 34105 Custom Lengths

Each of the 8 in-stock lengths can be cut to a custom length up to 2 inches shorter than the stock length. Turnaround time for custom lengths orders is 2 business days. A one-time customization charge of \$60.00 applies per order. (Note: Polished Chrome tab pulls cannot be cut to size.)

One-Time Customization Charge	\$60.00
Order Nr. 59331	

Paint Grade

For a fully integrated look, the Schwinn Clear Anodized tab pulls can be installed and finished with the cabinet paint when cabinetry is painted on site.

Schwinn Item 34105/448 Pull

529 x 20 x 22 mm

C/C 448 mm; M4 Thread

Clear Anodized	\$29.00
Order Nr. 59505	
Nickel Color	\$30.00
Order Nr. 59506	
Matte Black	\$30.00
Order Nr. 59508	
Polished Chrome	\$32.00
Order Nr. 59509	

Schwinn Item 34105/512 Pull

605 x 20 x 22 mm

C/C 512 mm; M4 Thread

Clear Anodized	\$36.00
Order Nr. 59510	
Nickel Color	\$38.00
Order Nr. 59511	
Matte Black	\$38.00
Order Nr. 59513	
Polished Chrome	\$40.00
Order Nr. 59514	

Schwinn Item 34105/704 Pull

757 x 20 x 22 mm

C/C 704 mm; M4 Thread

Clear Anodized	\$40.00
Order Nr. 59515	
Nickel Color	\$42.00
Order Nr. 59516	
Matte Black	\$42.00
Order Nr. 59518	
Polished Chrome	\$44.00
Order Nr. 59519	

Schwinn Item 34105/864 Pull

910 x 20 x 22 mm

C/C 864 mm; M4 Thread

Clear Anodized	\$50.00
Order Nr. 59520	
Nickel Color	\$52.00
Order Nr. 59521	
Matte Black	\$52.00
Order Nr. 59523	
Polished Chrome	\$54.00
Order Nr. 59524	

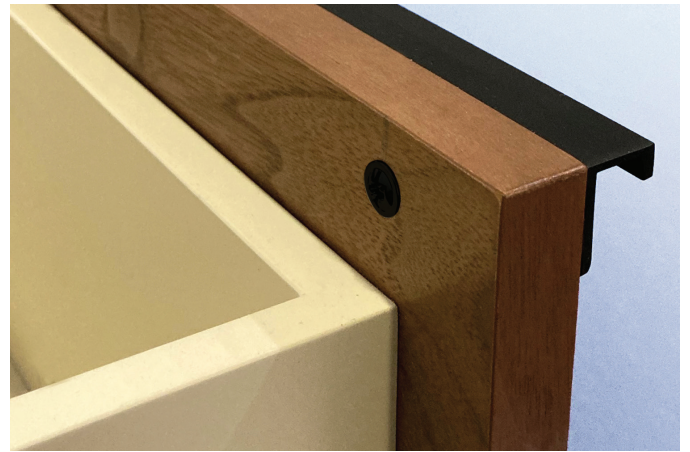

Available Finishes

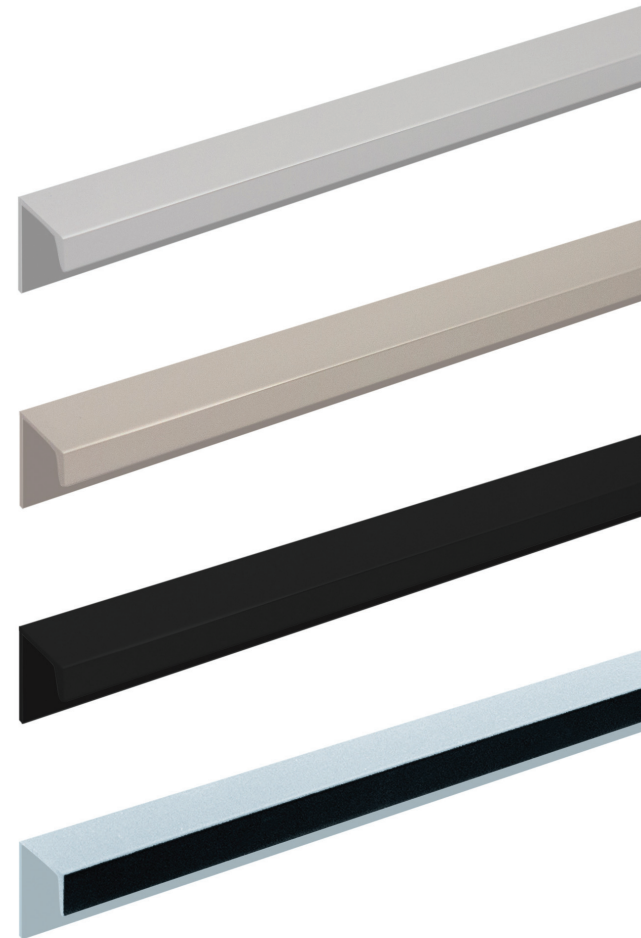

Schwinn Item 2Z313 Hook

Material: Zamak

Environmental Information:

- Fully Recyclable
- Meets RoHS Standards

50 x 50 x 41 mm

C/C 20 mm; Countersunk for #8 Screw Head

Mounting Type: Concealed

Load Capacity: 44 lb

Provided Hardware: None

Polished Chrome \$16.00

Order Nr. 59391

Matte Black \$16.00

Order Nr. 59392

Matte Gold \$17.00

Order Nr. 59394

Satin Nickel \$16.00

Order Nr. 59393



Compatible with Schwinn Item 88948 Hook Rack. 4 Hooks needed.
See pages 56-57 for details.

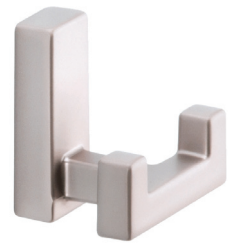
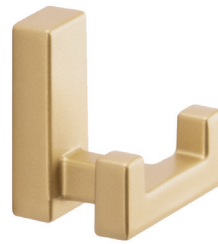
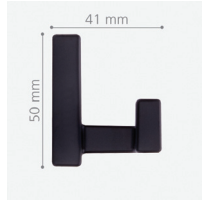
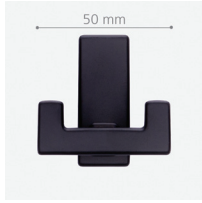

Schwinn Item 22390 Hook

Material: Zamak
 Environmental Information:
 - Fully Recyclable
 - Meets RoHS Standards

13 x 51 x 42 mm
 C/C 32; Countersunk for #8 Screw Head
 Mounting Type: Concealed
 Load Capacity: 44 lb
 Provided Hardware: None

Polished Chrome Order Nr. 59411	\$14.00
Matte Black Order Nr. 59414	\$14.00
Matte Gold Order Nr. 59413	\$15.00
Satin Nickel Order Nr. 59412	\$14.00

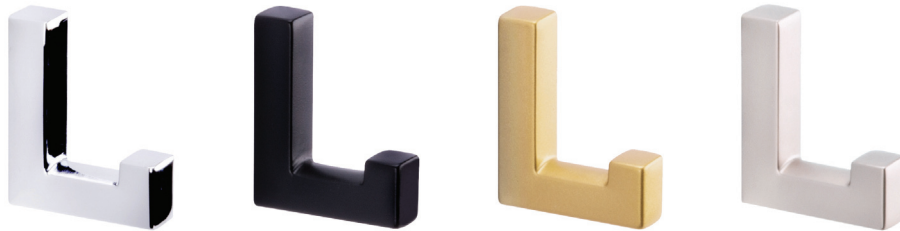

Compatible with Schwinn Item 88908 Hook Rack. 4 Hooks needed.
 See pages 56-57 for details.

Schwinn Item 33906 Hook

Material: Steel
 Environmental Information:
 - Fully Recyclable
 - Meets RoHS Standards

20 x 30 mm
 C/C 0; M6 Thread
 Mounting Type: Concealed
 Load Capacity: 33 lb
 Provided Hardware: Mounting Screw

Polished Chrome Order Nr. 59415	\$10.00
Matte Black Order Nr. 59418	\$10.00
Matte Gold Order Nr. 59417	\$10.00
Satin Nickel Order Nr. 59416	\$10.00

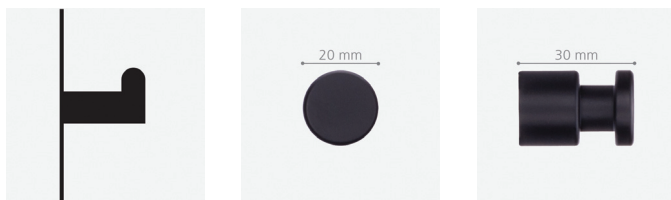

Compatible with Schwinn Item 88947 Hook Rack. 4 Hooks needed.
 See pages 56-57 for details.



Schwinn Item 2Z337 Hook

Material: Zamak

Environmental Information:

- Fully Recyclable
- Meets RoHS Standards

80 x 71 x 35 mm

C/C 32 mm; Countersunk for #8 Screw Head

Mounting Type: Concealed

Load Capacity: 44 lb

Provided Hardware: None

Polished Chrome \$15.00

Order Nr. 59395

Matte Black \$15.00

Order Nr. 59406

Satin Nickel \$15.00

Order Nr. 59396

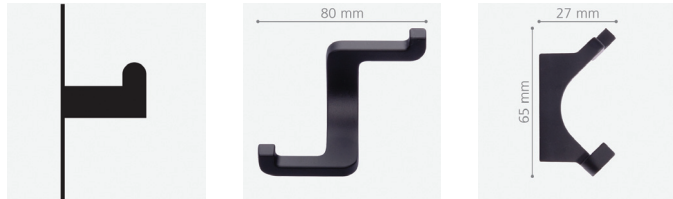

Compatible with Schwinn Item 88908 Hook Rack. 4 Hooks needed.
See pages 56-57 for details.



Schwinn Item 2Z327 Hook

Material: Zamak

Environmental Information:

- Fully Recyclable
- Meets RoHS Standards

58 x 65 x 27 mm

C/C 20 mm; Countersunk for #8 Screw Head

Mounting Type: Concealed

Load Capacity: 44 lb

Provided Hardware: None

Polished Chrome \$14.00

Order Nr. 59397

Matte Black \$14.00

Order Nr. 59398

Satin Nickel \$14.00

Order Nr. 59399



Compatible with Schwinn Item 88948 Hook Rack. 4 Hooks needed.
See pages 56-57 for details.



Schwinn 44410 Series

Material: Stainless Steel Grade 303

Environmental Information:

- Fully Recyclable
- Meets RoHS Standards

Schwinn Item 44410-26 Hook

35 x 10 x 26 mm

C/C 0; M4 Thread

Mounting Type: Concealed

Load Capacity: 33 lb

Provided Hardware: Mounting Screw

Brushed Stainless Steel

\$8.00

Order Nr. 53651

Schwinn Item 44410-41 Hook

35 x 14 x 41 mm

C/C 0; M4 Thread

Mounting Type: Concealed

Load Capacity: 33 lb

Provided Hardware: Mounting Screw

Brushed Stainless Steel

\$10.00

Order Nr. 53652

Schwinn Item 44410-61 Hook

35 x 14 x 61 mm

C/C 0; M4 Thread

Mounting Type: Concealed

Load Capacity: 33 lb

Provided Hardware: Mounting Screw

Brushed Stainless Steel

\$12.00

Order Nr. 53653

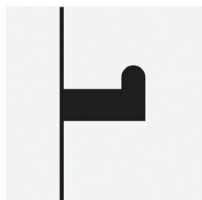

Compatible with Schwinn Item 88947 Hook Rack. 4 Hooks needed. See pages 56-57 for details.



Schwinn Item 33796 Swiveling Under-Mount Hook

Material: Stainless Steel Grade 303

Environmental Information:

- Fully Recyclable
- Meets RoHS Standards

60 x 45 x 60 mm

C/C 24 mm; Countersunk for #8 Screw Head

Load Capacity: 55 lb

Provided Hardware: None

Brushed Stainless Steel

\$26.00

Order Nr. 53436

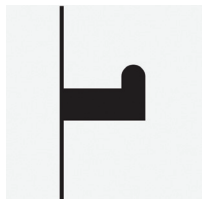

Create your own custom hook rack.

All Schwinn hook designs can be mounted on the Schwinn Hook Rack in multiples of four to create a unique modular hanging solution.

Step 1

Choose your hook style and finish; four hooks needed per hook rack.

Step 2

Choose your hook rack color; silver or anthracite.

Step 3

Select the appropriate hole profile for your hooks; single hole, C/C 20 mm or C/C 32 mm.

Once your order is placed (4 hooks plus 1 hook rack), Schwinn will do the assembly and ship your finished hook rack ready for installation, mounting hardware included.

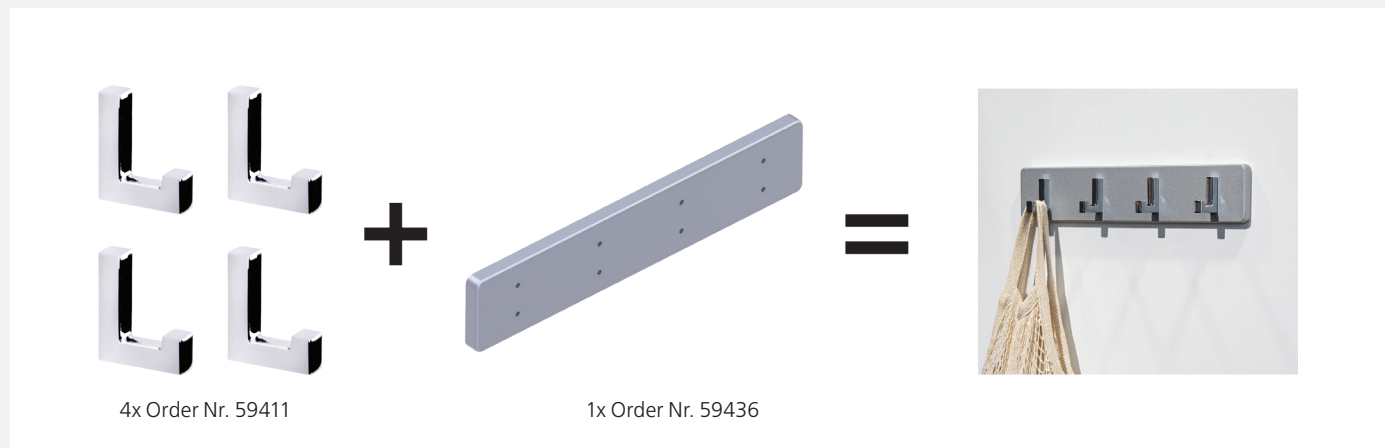

4x Order Nr. 53653 + 1x Order Nr. 59437



4x Order Nr. 59394 + 1x Order Nr. 59439



4x Order Nr. 59398 + 1x Order Nr. 59440



4x Order Nr. 59395 + 1x Order Nr. 59435

Schwinn Item 88947 Hook Rack

Material: Painted MDF

400 x 80 x 16 mm

Mounting Type: Concealed

Load Capacity: 55 lb

Provided Hardware: 4 Hook Mounting Screws,
2 Anchors, 2 Hook Screws

For use with 4 hooks each: Schwinn Items
44410, 22022, 44452, 33906, 88939, 88940
or 88941 (single hole).

Silver	\$12.00
Order Nr. 59438	
Anthracite	\$12.00
Order Nr. 59437	

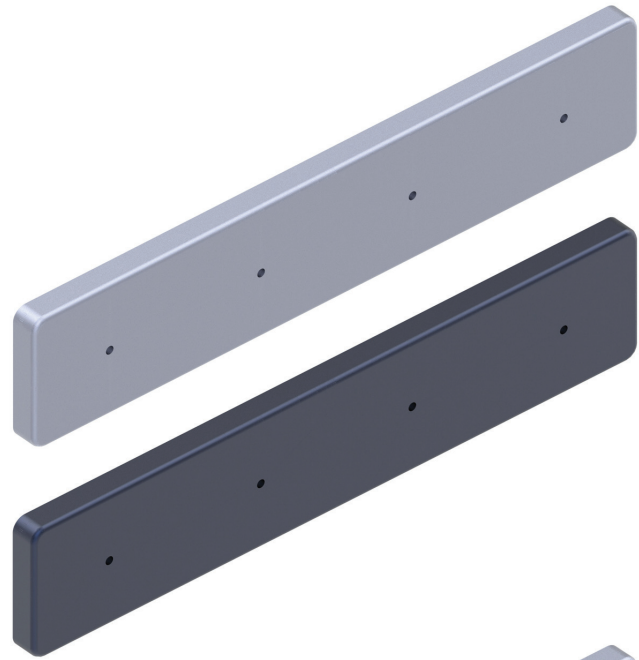

Schwinn Item 88948 Hook Rack

Material: Painted MDF

400 x 80 x 16 mm

Mounting Type: Concealed

Load Capacity: 55 lb

Provided Hardware: 8 Hook Mounting Screws,
2 Anchors, 2 Hook Screws

For use with 4 hooks each: Schwinn Items
2Z327, 2Z313, 2Z354, 2Z360 and 44683
(C/C 20 mm).

Silver	\$12.00
Order Nr. 59440	
Anthracite	\$12.00
Order Nr. 59439	

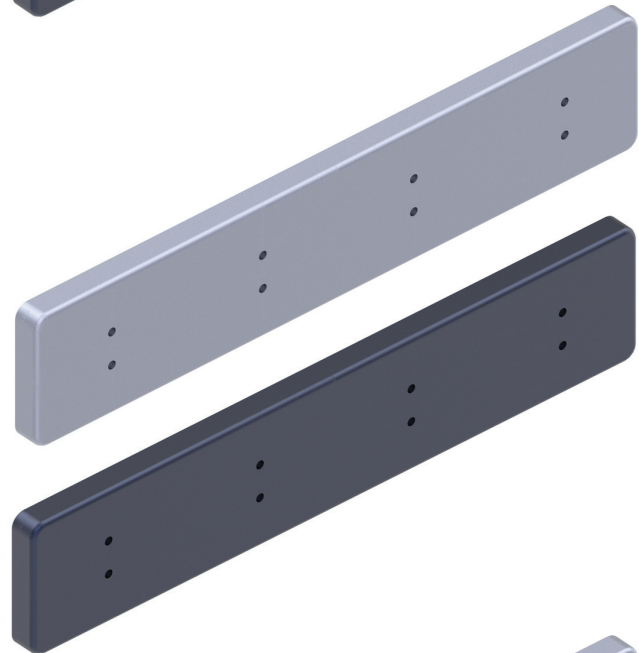

Schwinn Item 88908 Hook Rack

Material: Painted MDF

400 x 80 x 16 mm

Mounting Type: Concealed

Load Capacity: 55 lb

Provided Hardware: 8 Hook Mounting Screws,
2 Anchors, 2 Hook Screws

For use with 4 hooks each: Schwinn Item
2Z390, 2Z337 (C/C 32 mm).

Silver	\$12.00
Order Nr. 59436	
Anthracite	\$12.00
Order Nr. 59435	

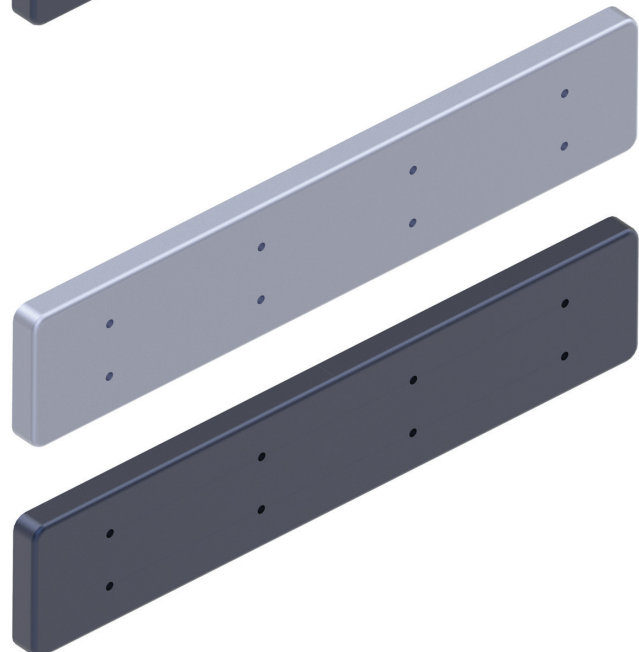

Schwinn 44398 Series

2-Piece Circular Cable Grommet

Material: Zamak

Cable Grip: Rubber Star Cut

Cap Fit: Twist Lock

Environmental Information:

- Fully Recyclable

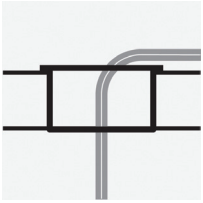

Schwinn Item 44398 Small Grommet

56 x 15 mm (2 7/32 x 9/16 in)

Hole: 50 mm (2 in)

Polished Chrome	\$7.00
-----------------	--------

Order Nr. 53468

Matte Chrome	\$7.00
--------------	--------

Order Nr. 53469

Matte Black	\$7.00
-------------	--------

Order Nr. 59332

Satin Nickel	\$7.00
--------------	--------

Order Nr. 59164



Schwinn Item 44398 Medium Grommet

68 x 15 mm (2 5/8 x 9/16 in)

Hole: 60 mm (2 3/8 in)

Polished Chrome	\$9.00
-----------------	--------

Order Nr. 53471

Matte Chrome	\$9.00
--------------	--------

Order Nr. 53472

Matte Black	\$9.00
-------------	--------

Order Nr. 59333

Satin Nickel	\$9.00
--------------	--------

Order Nr. 59167

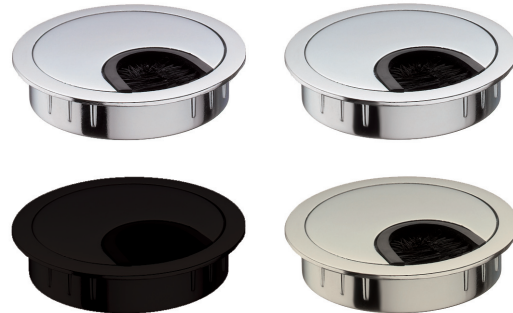

Schwinn Item 44398 Large Grommet

90 x 15 mm (3 1/2 x 9/16 in)

Hole: 80 mm (3 5/32 in)

Polished Chrome	\$10.00
-----------------	---------

Order Nr. 53474

Matte Chrome	\$10.00
--------------	---------

Order Nr. 53475

Matte Black	\$10.00
-------------	---------

Order Nr. 59334

Satin Nickel	\$10.00
--------------	---------

Order Nr. 59131

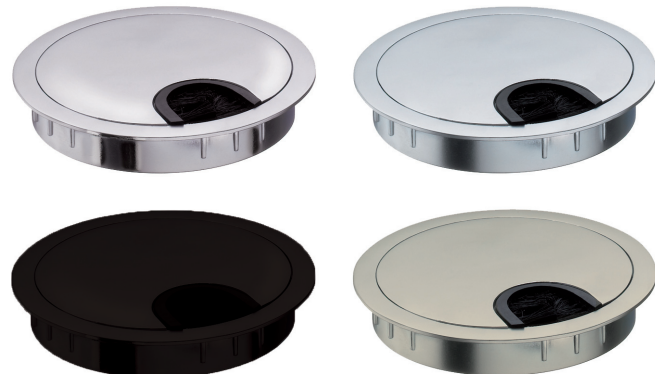

Schwinn
Handle-Free
Cabinet Hardware
CS3 Series



Schwinn Handle-Free Cabinet Hardware CS3 Series

Material: Aluminum

Environmental Information:

- Fully Recyclable
 - Meets RoHS Standards
- ADA Compliant: No

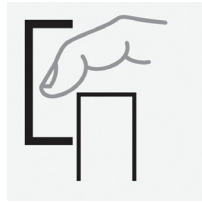

Schwinn Item 33913-290 C-Channel

2.9 meters x 72.5 mm x 26 mm

Clear Anodized	\$45.00
Order Nr. 59240	
Nickel Color	\$51.00
Order Nr. 59241	
Dark Bronze Color	\$51.00
Order Nr. 59242	
Matte Black	\$51.00
Order Nr. 59243	

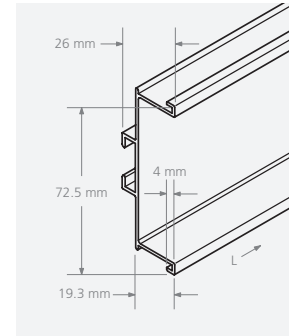
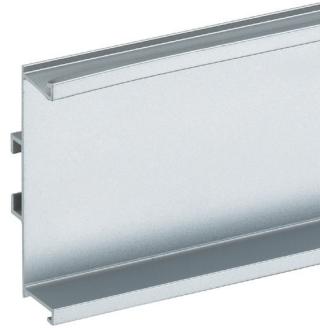

Schwinn Item 33914-290 L-Channel

2.9 meters x 56.5 mm x 26 mm

Clear Anodized	\$36.00
Order Nr. 59244	
Nickel Color	\$42.00
Order Nr. 59245	
Dark Bronze Color	\$42.00
Order Nr. 59246	
Matte Black	\$42.00
Order Nr. 59247	

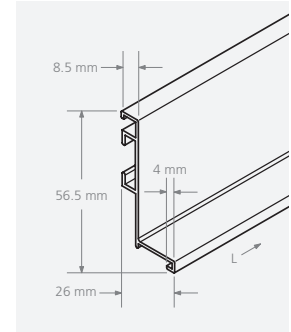
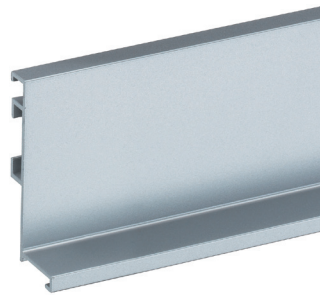

Schwinn Item 33915-290 Vertical Channel

2.9 meters x 67 mm x 42 mm

Clear Anodized	\$68.00
Order Nr. 59248	
Nickel Color	\$78.00
Order Nr. 59249	
Dark Bronze Color	\$78.00
Order Nr. 59250	
Matte Black	\$78.00
Order Nr. 59251	

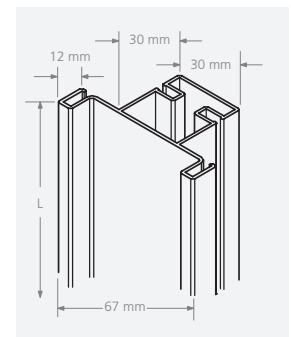
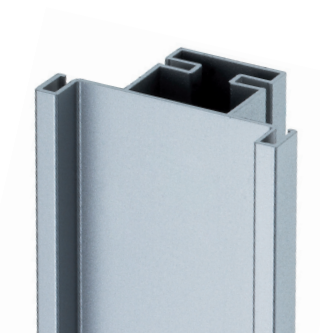

Schwinn Item 33916-290 Vertical End Channel

2.9 meters x 48.5 mm x 42 mm

Clear Anodized	\$60.00
Order Nr. 59252	
Nickel Color	\$68.00
Order Nr. 59253	
Dark Bronze Color	\$68.00
Order Nr. 59254	
Matte Black	\$68.00
Order Nr. 59255	

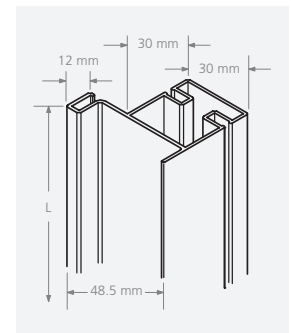

Schwinn Item 6K379

C Cap (L+R)

72.5 x 26 x 2 mm

Silver (matches Clear Anodized)	\$1.00
Order Nr. 59276	
Nickel Color	\$1.00
Order Nr. 59277	
Dark Bronze Color	\$1.00
Order Nr. 59278	
Matte Black	\$1.00
Order Nr. 59279	

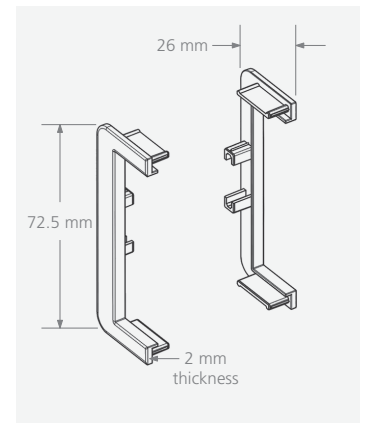
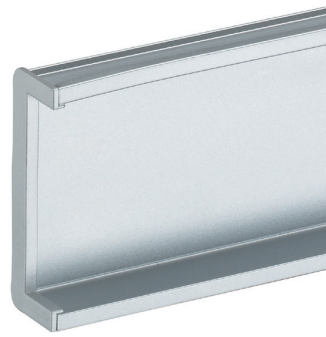

Schwinn Item 6K378

C Cap Rectangle (L+R)

72.5 x 26.5 x 2 mm

Silver (matches Clear Anodized)	\$1.00
Order Nr. 59272	
Nickel Color	\$1.00
Order Nr. 59273	
Dark Bronze Color	\$1.00
Order Nr. 59274	
Matte Black	\$1.00
Order Nr. 59275	

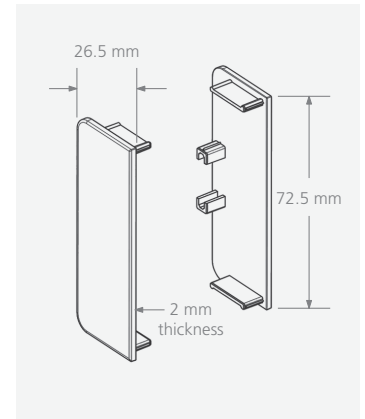
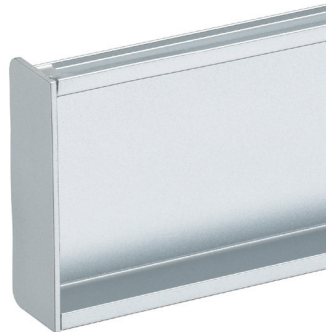

Schwinn Item 6K400-C

Outer Corner

72.5 x 28 x 28 mm

Silver (matches Clear Anodized)	\$1.50
Order Nr. 59288	
Nickel Color	\$1.50
Order Nr. 59289	
Dark Bronze Color	\$1.50
Order Nr. 59290	
Matte Black	\$1.50
Order Nr. 59291	

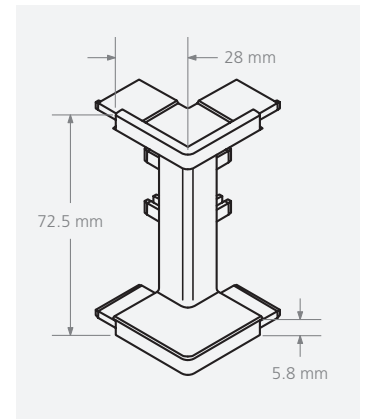
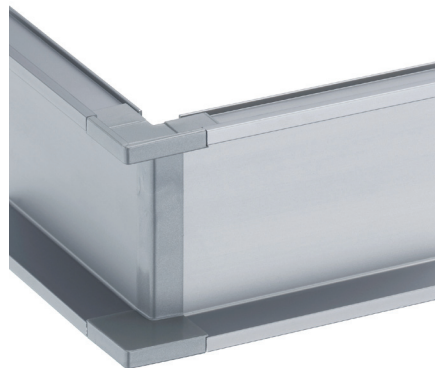

Schwinn Item 6K399-C

Inner Corner

72.7 x 22.9 x 27.4 mm

Silver (matches Clear Anodized)	\$1.50
Order Nr. 59280	
Nickel Color	\$1.50
Order Nr. 59281	
Dark Bronze Color	\$1.50
Order Nr. 59282	
Matte Black	\$1.50
Order Nr. 59283	

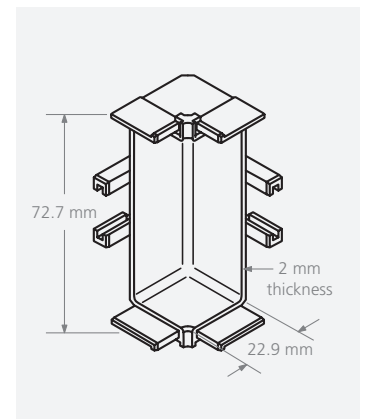

CAD drawings available on request.

Schwinn Item 6K376

L Cap Left

58 x 28 x 1 mm

Silver (matches Clear Anodized) \$1.00
Order Nr. 59256

Nickel Color \$1.00
Order Nr. 59257

Dark Bronze Color \$1.00
Order Nr. 59258

Matte Black \$1.00
Order Nr. 59259

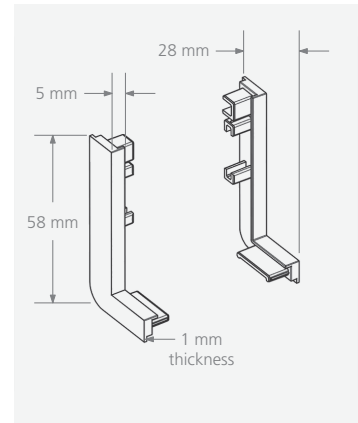

Schwinn Item 6K376

L Cap Right

58 x 28 x 1 mm

Silver (matches Clear Anodized) \$1.00
Order Nr. 59260

Nickel Color \$1.00
Order Nr. 59261

Dark Bronze Color \$1.00
Order Nr. 59262

Matte Black \$1.00
Order Nr. 59263



Schwinn Item 6K377

L Cap Rectangle Left

56.5 x 27 x 2 mm

Silver (matches Clear Anodized) \$1.00
Order Nr. 59264

Nickel Color \$1.00
Order Nr. 59265

Dark Bronze Color \$1.00
Order Nr. 59266

Matte Black \$1.00
Order Nr. 59267

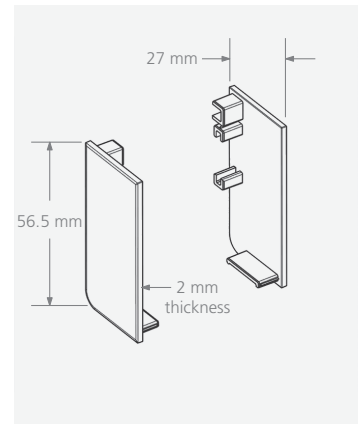
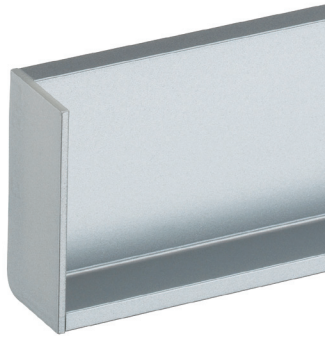

Schwinn Item 6K377

L Cap Rectangle Right

56.5 x 27 x 2 mm

Silver (matches Clear Anodized) \$1.00
Order Nr. 59268

Nickel Color \$1.00
Order Nr. 59269

Dark Bronze Color \$1.00
Order Nr. 59270

Matte Black \$1.00
Order Nr. 59271



Schwinn Item 6K400-L

Outer Corner

56.5 x 28 x 28 mm

Silver (matches Clear Anodized) \$1.50
Order Nr. 59292

Nickel Color \$1.50
Order Nr. 59293

Dark Bronze Color \$1.50
Order Nr. 59294

Matte Black \$1.50
Order Nr. 59295

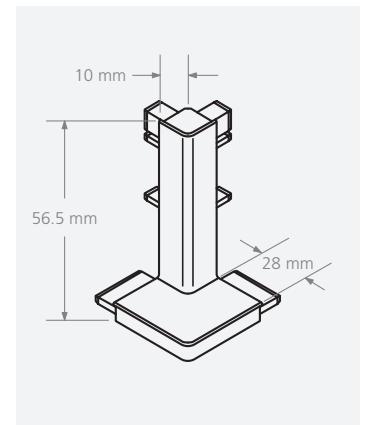
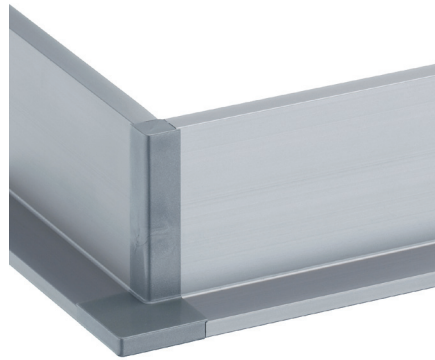

Schwinn Item 6K399-L

Inner Corner

56.6 x 28.5 x 28.5 mm

Silver (matches Clear Anodized) \$1.50
Order Nr. 59284

Nickel Color \$1.50
Order Nr. 59285

Dark Bronze Color \$1.50
Order Nr. 59286

Matte Black \$1.50
Order Nr. 59287

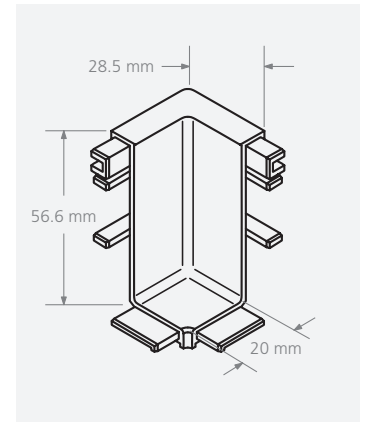
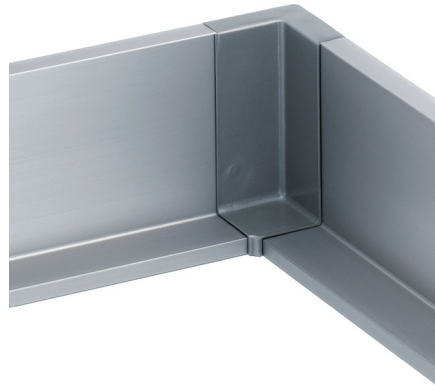

Schwinn Item 6K136

Corner Bracket

Use with L and C Channel
C/C 16 mm; #6 Wood Screw

Light Gray \$1.00
Order Nr. 59298

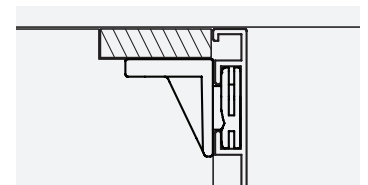
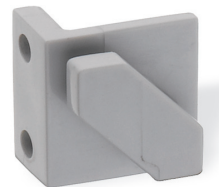

Schwinn Item 6K350

90 Degree Connector

Use with L and C Channel

Light Gray \$1.00
Order Nr. 59297

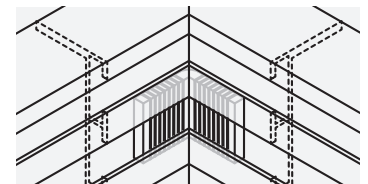
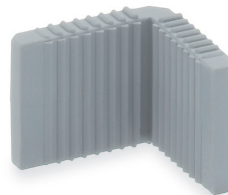

Schwinn Item 6K351

Straight Bracket

Use with L and C Channel

Light Gray \$1.00
Order Nr. 59296

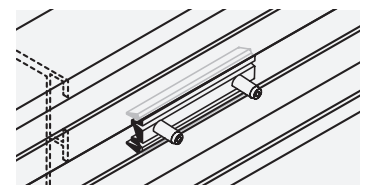
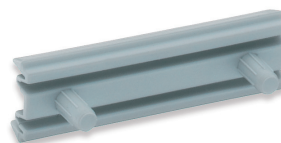

CAD drawings available on request.

L-Channel Installation Detail

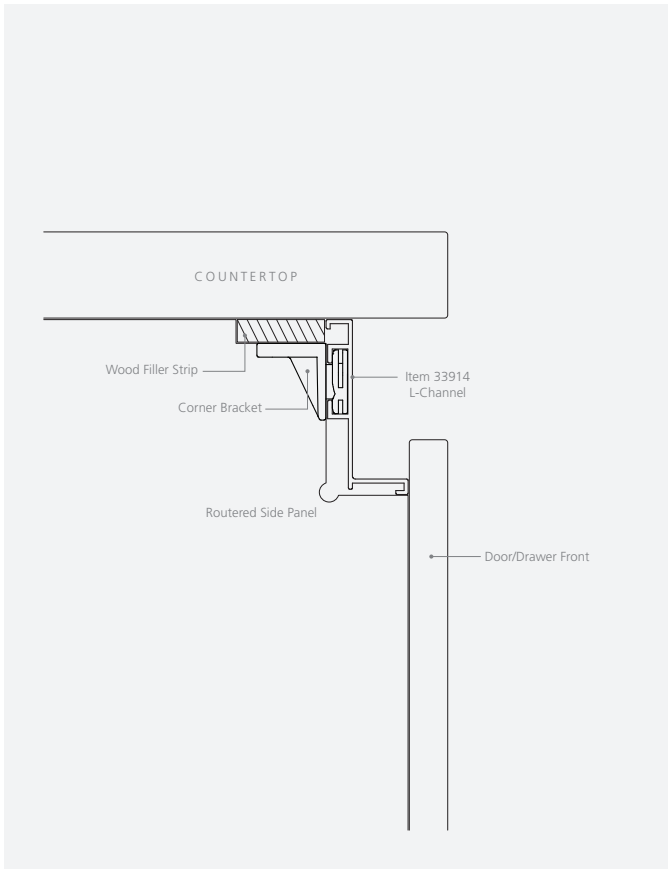

Wall Abutment Detail

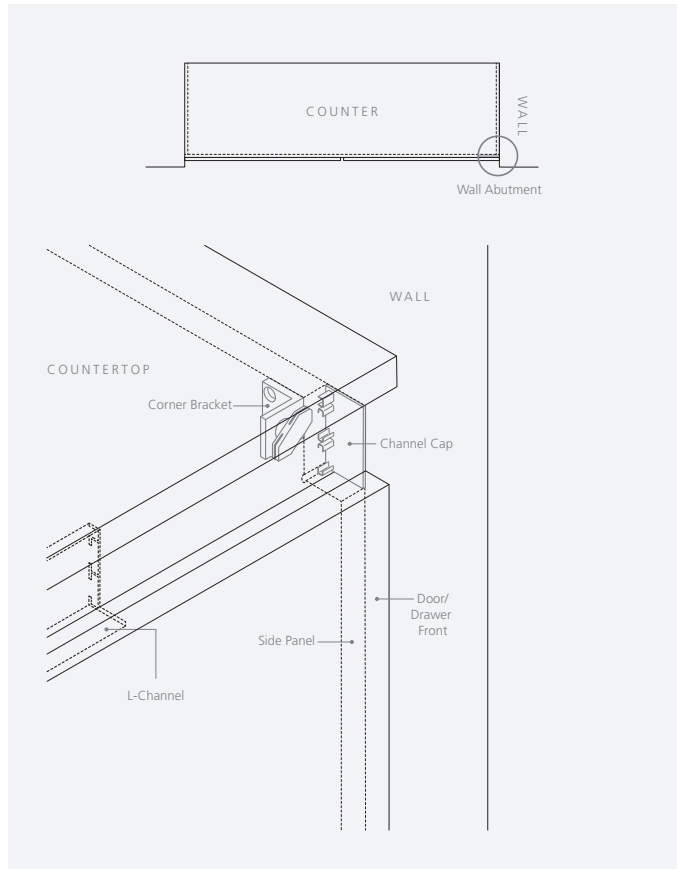

Wall Abutment with Filler Panel Detail

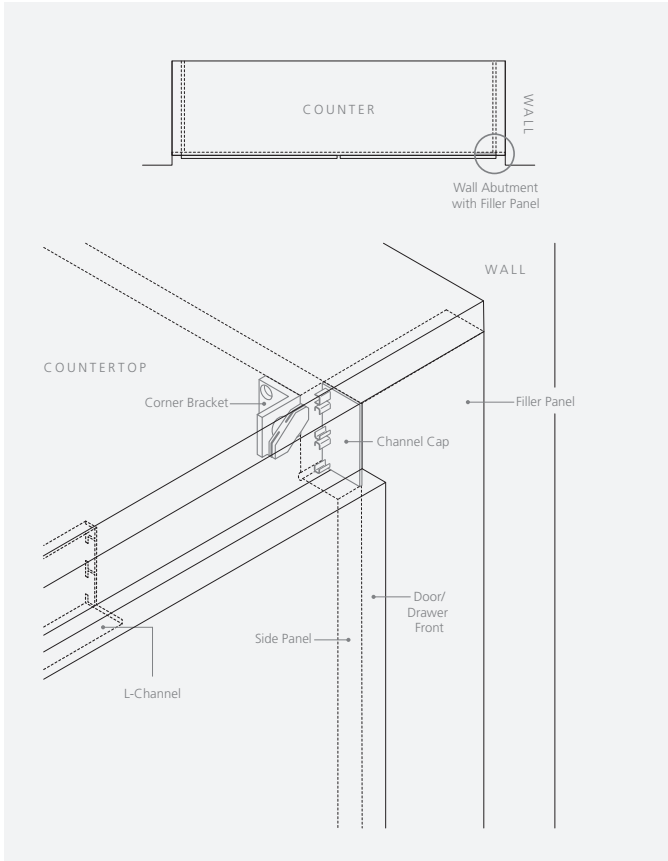

Side Panel Abutment Detail

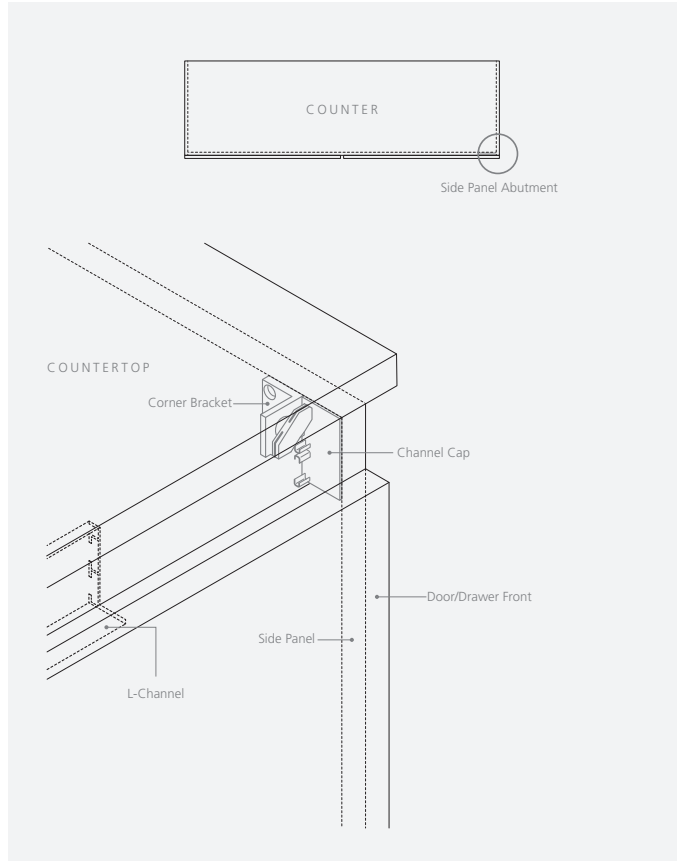

Mitered Outer Corner Detail

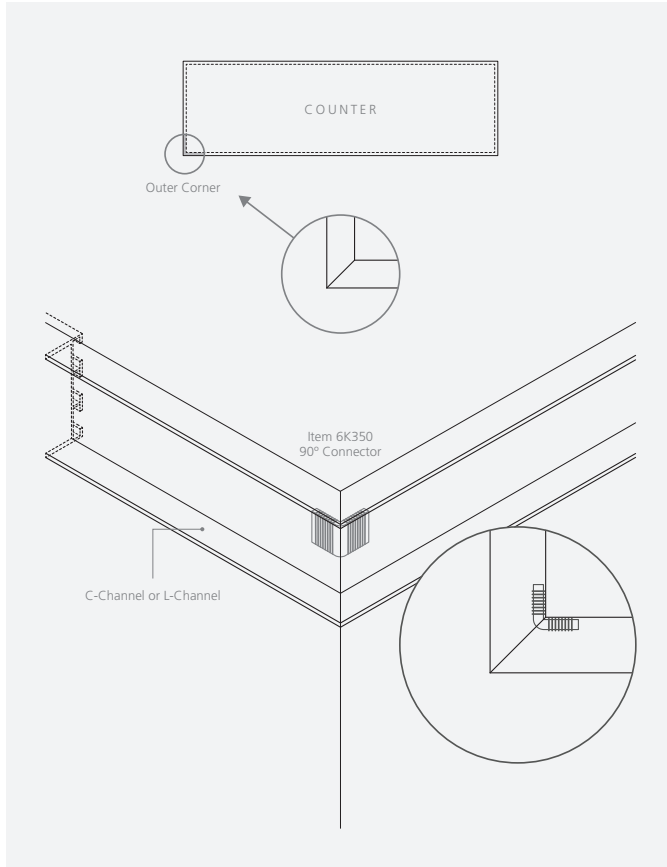

Straight Cut Outer Corner Detail

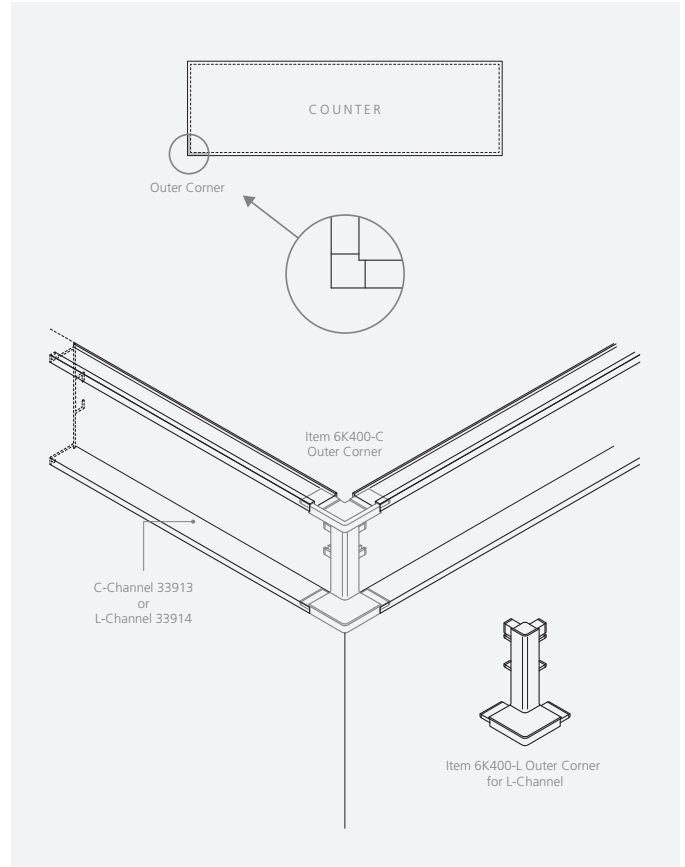

Straight Cut Inner Corner Detail

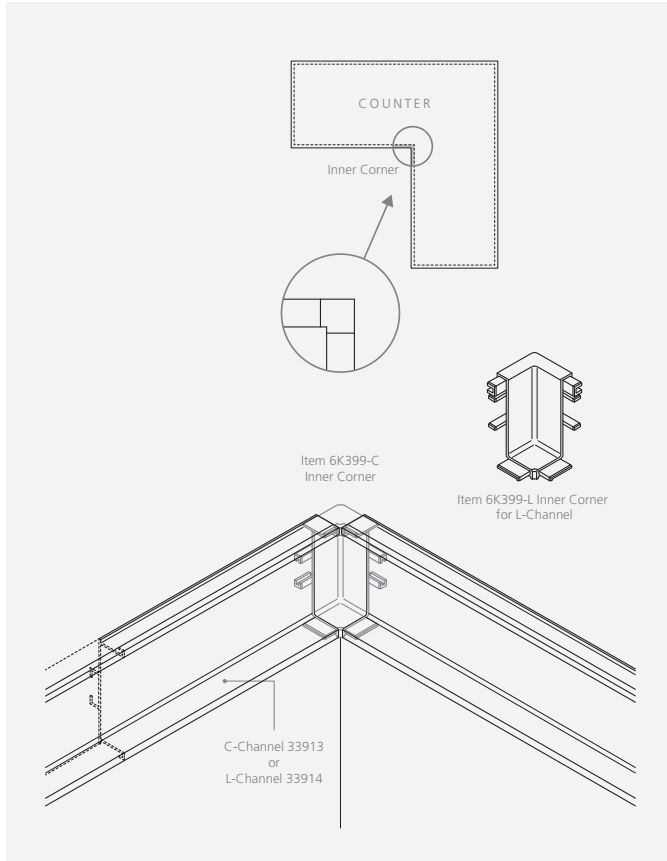

Seam Detail

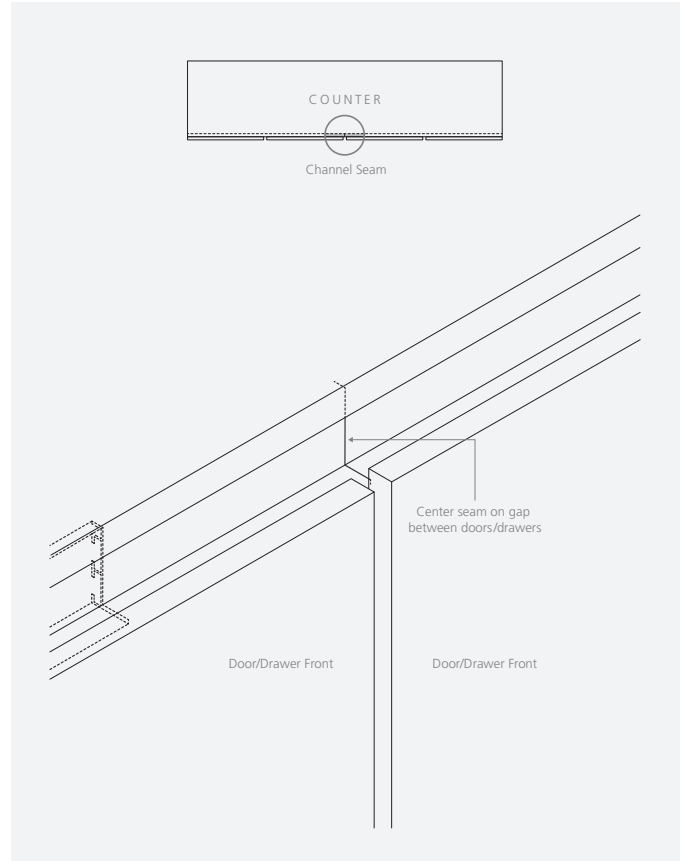

Product Index

By Order Number:

Order Nr.	Item Nr.	Page	Order Nr.	Item Nr.	Page	Order Nr.	Item Nr.	Page	Order Nr.	Item Nr.	Page
50009	33132	33	59003	33766	48	59182	2Z395	19	59269	6K377 R	62
50010	33132	33	59004	33766	48	59183	2Z395	19	59270	6K377 R	62
50011	33132	33	59005	33766	48	59184	2Z395	19	59271	6K377 R	62
50012	33132	33	59006	33766	48	59185	2Z395	19	59272	6K378	61
50700	22022	9	59007	33766	49	59186	2Z395	19	59273	6K378	61
50701	22022	9	59009	22518	42	59187	2Z395	19	59274	6K378	61
51473	33243	22	59011	33766	49	59188	2Z395	19	59275	6K378	61
51474	33243	22	59012	33766	49	59189	2Z395	19	59276	6K379	61
51475	33243	22	59014	2Z306	18	59190	2Z395	19	59277	6K379	61
51477	33243	22	59015	2Z306	18	59191	2Z395	19	59278	6K379	61
51479	33243	22	59016	2Z306	18	59192	2Z395	19	59279	6K379	61
51482	33243	22	59017	2Z306	18	59193	2Z395	19	59280	6K399	61
51515	44537	39	59022	2Z306	18	59194	44702	32	59281	6K399	61
51747	22334	14	59027	22548	15	59195	44702	32	59282	6K399	61
51749	22334	14	59028	22548	15	59196	44702	32	59283	6K399	61
51877	22389	16	59035	2Z306	18	59197	44702	32	59284	6K399	63
51948	44452	39	59036	2Z306	18	59198	44702	32	59285	6K399	63
51970	44141	8	59037	2Z306	18	59199	44702	32	59286	6K399	63
51984	44135	24	59038	2Z306	18	59200	44702	32	59287	6K399	63
51985	44135	24	59039	2Z306	18	59201	44702	32	59288	6K400	61
51986	44135	24	59040	2Z306	18	59202	44702	32	59289	6K400	61
51988	44135	24	59042	2Z306	18	59203	44702	32	59290	6K400	61
51990	44135	24	59045	22334	14	59204	44702	32	59291	6K400	61
51993	44135	24	59046	22334	14	59205	44702	32	59292	6K400	63
52242	33289	26	59055	22891	38	59206	34043	13	59293	6K400	63
52243	33289	26	59056	22891	38	59207	34043	13	59294	6K400	63
52244	33289	26	59057	22891	38	59208	34043	13	59295	6K400	63
52246	33289	26	59058	2Z078	43	59209	34043	13	59296	6K351	63
52248	33289	26	59068	33793	44	59210	34043	13	59297	6K350	63
52251	33289	26	59069	33793	44	59211	34043	13	59298	6K136	63
52288	22518	42	59070	33793	44	59212	34043	13	59299	33766	48
52313	33343	27	59071	33793	44	59213	34043	13	59300	33766	48
52315	33343	27	59078	22607	9	59214	34043	13	59301	33766	48
52358	22930	21	59085	33756	35	59215	33998	30	59302	33766	48
52518	22891	38	59086	33756	35	59216	33998	30	59303	33766	49
52519	22891	38	59087	22389	17	59217	33998	30	59304	33766	49
52555	22607	9	59088	22389	17	59218	33998	31	59305	33766	49
52682	22518	42	59089	22389	16	59219	33998	31	59306	33766	49
52834	22389	16	59090	22389	16	59220	33998	31	59307	33766	48
52836	22389	16	59091	22389	16	59221	33998	31	59308	33766	48
52837	22389	17	59092	22389	16	59222	33998	31	59309	33766	48
52901	22935	10	59093	22389	17	59223	33998	31	59310	33766	48
53172	22389	16	59094	22389	17	59224	33998	31	59311	33766	49
53203	2Z045	34	59095	22389	17	59225	33998	31	59312	33766	49
53205	2Z045	34	59096	22334	14	59226	33998	31	59313	33766	49
53206	2Z045	34	59097	22334	14	59227	33998	31	59314	33766	49
53208	2Z045	34	59099	22548	15	59228	33998	31	59315	33766	48
53213	22891	38	59100	22548	15	59229	33998	31	59316	33766	48
53214	22891	38	59110	2Z114	12	59230	33651	47	59317	33766	48
53216	22891	38	59111	2Z114	12	59231	33651	47	59318	33766	48
53217	22891	38	59113	44588	23	59232	33651	47	59319	33766	49
53218	33756	35	59114	44588	23	59233	33651	47	59320	33766	49
53220	33756	35	59115	44588	23	59234	33651	47	59321	33766	49
53355	22518	42	59116	44587	25	59240	33913	60	59322	33766	49
53358	2Z078	43	59117	44587	25	59241	33913	60	59323	33766	48
53360	2Z078	43	59118	44587	25	59242	33913	60	59324	33766	48
53436	33796	55	59119	33343	27	59243	33913	60	59325	33766	48
53468	44398	58	59120	33343	27	59244	33914	60	59326	33766	48
53469	22891	38	59121	33343	27	59245	33914	60	59327	33766	49
53469	44398	58	59125	22930	21	59246	33914	60	59328	33766	49
53471	44398	58	59130	2Z198	11	59247	33914	60	59329	33766	49
53472	44398	58	59131	44398	58	59248	33915	60	59330	33766	49
53474	44398	58	59138	2Z199	11	59249	33915	60	59332	44398	58
53475	44398	58	59139	2Z199	11	59250	33915	60	59333	44398	58
53651	44410	55	59143	2Z204	45	59251	33915	60	59334	44398	58
53652	44410	55	59147	2Z240	20	59252	33916	60	59337	33793	44
53653	44410	55	59148	2Z240	20	59253	33916	60	59338	22935	10
53757	2Z240	20	59149	2Z240	20	59254	33916	60	59340	33793	44
53760	2Z240	20	59150	2Z240	20	59255	33916	60	59341	22022	9
53769	2Z204	45	59151	2Z240	20	59256	6K376 L	62	59342	22022	9
53866	22930	21	59152	2Z240	20	59257	6K376 L	62	59343	22607	9
53896	2Z198	11	59153	2Z240	20	59258	6K376 L	62	59344	22607	9
54230	22389	16	59154	2Z245	45	59259	6K376 L	62	59345	22518	42
54232	22389	16	59156	2Z245	45	59260	6K376 R	62	59346	2Z078	43
54233	22389	16	59161	22930	21	59261	6K376 R	62	59348	22891	38
54234	22389	16	59164	44398	58	59262	6K376 R	62	59350	22891	38
54235	22389	17	59167	44398	58	59263	6K377 L	62	59351	33756	35
54298	2Z273	12	59177	2Z306	18	59264	6K376 R	62	59352	33756	35
54350	33958	28	59178	2Z306	18	59265	6K377 L	62	59353	33756	35
54351	33958	28	59179	2Z306	18	59266	6K377 L	62	59354	33756	35
54352	33958	28	59180	22334	14	59267	6K377 L	62	59355	22389	16
54401	2Z221	41	59181	22334	14	59268	6K377 R	62	59356	22389	16

By Item Number:

Order Nr.	Item Nr.	Page	Order Nr.	Item Nr.	Page	Item Nr.	Order Nr.	Page	Item Nr.	Order Nr.	Page
59357	22389	16	59442	33793	44	22022	50701	9	22891	59056	38
59358	22389	16	59443	33793	44	22022	59342	9	22891	59428	38
59359	22389	17	59444	33793	44	22022	59341	9	22891	53217	38
59360	22389	17	59445	33793	44	22022	50700	9	22891	59350	38
59361	22389	17	59446	33793	44	22022	59704	9	22891	59429	38
59362	22389	16	59447	33793	44	22334	51749	14	22891	53216	38
59363	22389	16	59448	33793	44	22334	59371	14	22891	59057	38
59364	22389	16	59449	33793	44	22334	59373	14	22891	59430	38
59365	22389	16	59450	34095	46	22334	51747	14	22930	59161	21
59366	22389	17	59451	34095	46	22334	59046	14	22930	59737	21
59367	22389	17	59452	34095	46	22334	59096	14	22930	52358	21
59368	22389	17	59453	34095	46	22334	59181	14	22930	53866	21
59369	22389	17	59454	34095	46	22334	59372	14	22930	59125	21
59370	22389	17	59455	34095	46	22334	59374	14	22935	52901	10
59371	22334	14	59456	34095	46	22334	59180	14	22935	59419	10
59372	22334	14	59457	34095	46	22334	59045	14	22935	59338	10
59373	22334	14	59458	34095	46	22334	59097	14	22935	59420	10
59374	22334	14	59459	34095	46	22389	54230	16	33132	50009	33
59375	22245	45	59460	34096	36	22389	59355	16	33132	50010	33
59376	22245	45	59461	34096	36	22389	59362	16	33132	50011	33
59379	44141	8	59462	34096	36	22389	52834	16	33132	50012	33
59380	44141	8	59463	34096	36	22389	59089	16	33243	51473	22
59381	44141	8	59464	34096	36	22389	54232	16	33243	51474	22
59382	44141	8	59465	34096	36	22389	59356	16	33243	51475	22
59383	22273	12	59466	34096	36	22389	59363	16	33243	51477	22
59384	22273	12	59467	34096	36	22389	51877	16	33243	51479	22
59385	22273	12	59468	34096	36	22389	59090	16	33243	51482	22
59386	22221	41	59469	34096	36	22389	54233	16	33289	52242	26
59387	22221	41	59470	34097	37	22389	59357	16	33289	52243	26
59388	22326	40	59471	34097	37	22389	59364	16	33289	52244	26
59389	22326	40	59472	34097	37	22389	52836	16	33289	52246	26
59390	22326	40	59473	34097	37	22389	59091	16	33289	52248	26
59391	22313	52	59474	34097	37	22389	54234	16	33289	52251	26
59392	22313	52	59475	34097	37	22389	59358	16	33343	52313	27
59393	22313	52	59476	34097	37	22389	59365	16	33343	52315	27
59394	22313	52	59477	34097	37	22389	53172	16	33343	59119	27
59395	22337	54	59478	34097	37	22389	59092	16	33343	59120	27
59396	22337	54	59479	34097	37	22389	54235	17	33343	59121	27
59397	22327	54	59480	22114	12	22389	59359	17	33651	59230	47
59398	22327	54	59481	33766	49	22389	59366	17	33651	59231	47
59399	22327	54	59482	33766	49	22389	52837	17	33651	59232	47
59400	33958	28	59483	33766	49	22389	59093	17	33651	59233	47
59401	33956	29	59484	33766	49	22389	59369	17	33651	59234	47
59402	33956	29	59485	34105	50	22389	59360	17	33651	59407	47
59404	44537	39	59486	34105	50	22389	59367	17	33756	53218	35
59405	33998	30	59488	34105	50	22389	59087	17	33756	59085	35
59406	22337	54	59489	34105	50	22389	59094	17	33756	59353	35
59407	33651	47	59490	34105	50	22389	59370	17	33756	59351	35
59408	22766	8	59491	34105	50	22389	59361	17	33756	53220	35
59409	22766	8	59493	34105	50	22389	59368	17	33756	59086	35
59410	22766	8	59494	34105	50	22389	59088	17	33756	59354	35
59411	22390	53	59495	34105	50	22389	59095	17	33756	59352	35
59412	22390	53	59496	34105	50	22518	53355	42	33766	59299	48
59413	22390	53	59498	34105	50	22518	59009	42	33766	59307	48
59414	22390	53	59499	34105	50	22518	52682	42	33766	59315	48
59415	33906	53	59500	34105	50	22518	59345	42	33766	59323	48
59416	33906	53	59501	34105	50	22518	52288	42	33766	59003	48
59417	33906	53	59503	34105	50	22548	59432	15	33766	59300	48
59418	33906	53	59504	34105	50	22548	59431	15	33766	59308	48
59419	22935	10	59505	34105	51	22548	59027	15	33766	59316	48
59420	22935	10	59506	34105	51	22548	59099	15	33766	59324	48
59421	22045	34	59508	34105	51	22548	59434	15	33766	59004	48
59422	22045	34	59509	34105	51	22548	59433	15	33766	59301	48
59423	22045	34	59510	34105	51	22548	59028	15	33766	59309	48
59424	22045	34	59511	34105	51	22548	59100	15	33766	59317	48
59425	22891	38	59513	34105	51	22607	59078	9	33766	59325	48
59426	22891	38	59514	34105	51	22607	59344	9	33766	59005	48
59427	22891	38	59515	34105	51	22607	59343	9	33766	59302	48
59428	22891	38	59516	34105	51	22607	52555	9	33766	59310	48
59429	22891	38	59518	34105	51	22766	59408	8	33766	59318	48
59430	22891	38	59519	34105	51	22766	59410	8	33766	59326	48
59431	22548	15	59520	34105	51	22766	59409	8	33766	59006	48
59432	22548	15	59521	34105	51	22891	53214	38	33766	59303	49
59433	22548	15	59523	34105	51	22891	59348	38	33766	59311	49
59434	22548	15	59524	34105	51	22891	59425	38	33766	59319	49
59435	88908	56	59704	22022	9	22891	53213	38	33766	59327	49
59436	88908	56	59737	22930	21	22891	59055	38	33766	59441	49
59437	88947	56				22891	59426	38	33766	59304	49
59438	88947	56				22891	52519	38	33766	59312	49
59439	88948	56				22891	53469	38	33766	59320	49
59440	88948	56				22891	59427	38	33766	59328	49
59441	33766	49				22891	52518	38	33766	59007	49

Item Nr.	Order Nr.	Page	Item Nr.	Order Nr.	Page	Item Nr.	Order Nr.	Page	Item Nr.	Order Nr.	Page
33766	59305	49	34095	59454	46	44398	59131	58	22306	59179	18
33766	59313	49	34095	59452	46	44410	53651	55	22306	59178	18
33766	59321	49	34095	59451	46	44410	53652	55	22306	59177	18
33766	59329	49	34095	59455	46	44410	53653	55	22306	59040	18
33766	59011	49	34095	59458	46	44452	51948	39	22306	59042	18
33766	59306	49	34095	59459	46	44537	51515	39	22313	59391	52
33766	59314	49	34095	59457	46	44537	59404	39	22313	59392	52
33766	59322	49	34095	59456	46	44587	59116	25	22313	59394	52
33766	59330	49	34096	59460	36	44587	59117	25	22313	59393	52
33766	59012	49	34096	59463	36	44587	59118	25	22326	59389	40
33766	59481	49	34096	59464	36	44588	59113	23	22326	59388	40
33766	59482	49	34096	59462	36	44588	59114	23	22326	59390	40
33766	59483	49	34096	59461	36	44588	59115	23	22327	59397	54
33766	59484	49	34096	59465	36	44702	59194	32	22327	59398	54
33793	59069	44	34096	59468	36	44702	59196	32	22327	59399	54
33793	59070	44	34096	59469	36	44702	59195	32	22337	59395	54
33793	59340	44	34096	59467	36	44702	59197	32	22337	59406	54
33793	59442	44	34096	59466	36	44702	59199	32	22337	59396	54
33793	59337	44	34097	59470	37	44702	59198	32	22390	59411	53
33793	59071	44	34097	59473	37	44702	59200	32	22390	59414	53
33793	59068	44	34097	59474	37	44702	59202	32	22390	59413	53
33793	59444	44	34097	59472	37	44702	59201	32	22390	59412	53
33793	59445	44	34097	59471	37	44702	59203	32	22395	59184	19
33793	59448	44	34097	59475	37	44702	59205	32	22395	59183	19
33793	59449	44	34097	59478	37	44702	59204	32	22395	59182	19
33793	59447	44	34097	59479	37	88908	59436	56	22395	59185	19
33793	59446	44	34097	59477	37	88908	59435	56	22395	59188	19
33793	59443	44	34097	59476	37	88947	59438	56	22395	59187	19
33796	53436	55	34105	59485	50	88947	59437	56	22395	59186	19
33906	59415	53	34105	59486	50	88948	59440	56	22395	59189	19
33906	59418	53	34105	59488	50	88948	59439	56	22395	59192	19
33906	59417	53	34105	59489	50	22045	53203	34	22395	59191	19
33906	59416	53	34105	59490	50	22045	59421	34	22395	59190	19
33913	59240	60	34105	59491	50	22045	59422	34	22395	59193	19
33913	59241	60	34105	59493	50	22045	53205	34	6K136	59298	63
33913	59242	60	34105	59494	50	22045	53206	34	6K350	59297	63
33913	59243	60	34105	59495	50	22045	59423	34	6K351	59296	63
33914	59244	60	34105	59496	50	22045	59424	34	6K376 L	59256	62
33914	59245	60	34105	59498	50	22045	53208	34	6K376 L	59257	62
33914	59246	60	34105	59499	50	22078	53358	43	6K376 L	59258	62
33914	59247	60	34105	59500	50	22078	59346	43	6K376 L	59259	62
33915	59248	60	34105	59501	50	22078	53360	43	6K376 R	59260	62
33915	59249	60	34105	59503	50	22078	59058	43	6K376 R	59261	62
33915	59250	60	34105	59504	50	22114	59110	12	6K376 R	59262	62
33915	59251	60	34105	59505	51	22114	59480	12	6K376 R	59264	62
33916	59252	60	34105	59506	51	22114	59111	12	6K377 L	59263	62
33916	59253	60	34105	59508	51	22198	53896	11	6K377 L	59265	62
33916	59254	60	34105	59509	51	22198	59130	11	6K377 L	59266	62
33916	59255	60	34105	59510	51	22199	59139	11	6K377 L	59267	62
33956	59401	29	34105	59511	51	22199	59138	11	6K377 R	59268	62
33956	59402	29	34105	59513	51	22204	53769	45	6K377 R	59269	62
33958	54350	28	34105	59514	51	22204	59143	45	6K377 R	59270	62
33958	54351	28	34105	59515	51	22221	54401	41	6K377 R	59271	62
33958	54352	28	34105	59516	51	22221	59386	41	6K378	59272	61
33958	59400	28	34105	59518	51	22221	59387	41	6K378	59273	61
33998	59405	30	34105	59519	51	22240	59147	20	6K378	59274	61
33998	59216	30	34105	59520	51	22240	59148	20	6K378	59275	61
33998	59215	30	34105	59521	51	22240	59149	20	6K379	59276	61
33998	59217	30	34105	59523	51	22240	53760	20	6K379	59277	61
33998	59219	31	34105	59524	51	22240	59150	20	6K379	59278	61
33998	59218	31	44135	51984	24	22240	59151	20	6K379	59279	61
33998	59220	31	44135	51985	24	22240	53757	20	6K399	59280	61
33998	59222	31	44135	51986	24	22240	59152	20	6K399	59281	61
33998	59221	31	44135	51988	24	22240	59153	20	6K399	59282	61
33998	59223	31	44135	51990	24	22245	59154	45	6K399	59283	61
33998	59225	31	44135	51993	24	22245	59375	45	6K399	59284	63
33998	59224	31	44141	51970	8	22245	59376	45	6K399	59285	63
33998	59226	31	44141	59381	8	22245	59156	45	6K399	59286	63
33998	59228	31	44141	59380	8	22273	54298	12	6K399	59287	63
33998	59227	31	44141	59379	8	22273	59384	12	6K400	59288	61
33998	59229	31	44141	59382	8	22273	59385	12	6K400	59289	61
34043	59206	13	44398	53468	58	22273	59383	12	6K400	59290	61
34043	59208	13	44398	53469	58	22306	59022	18	6K400	59291	61
34043	59207	13	44398	59332	58	22306	59017	18	6K400	59292	63
34043	59209	13	44398	59164	58	22306	59016	18	6K400	59293	63
34043	59211	13	44398	53471	58	22306	59014	18	6K400	59294	63
34043	59210	13	44398	53472	58	22306	59015	18	6K400	59295	63
34043	59212	13	44398	59333	58	22306	59039	18			
34043	59214	13	44398	59167	58	22306	59038	18			
34043	59213	13	44398	53474	58	22306	59037	18			
34095	59450	46	44398	53475	58	22306	59035	18			
34095	59453	46	44398	59334	58	22306	59036	18			

General Information

- 1.** Terms: Net 30 days on established credit.
- 2.** Shipping and handling: all orders are shipped FOB Scottsdale, Arizona. Standard service level is ground shipping. Fees apply. Third party and rush shipping available. Please provide account number and specify service level. Drop shipment available upon request.
- 3.** Returned goods: merchandise may be returned only with our approval within 30 days of receipt of merchandise. A Schwinn issued RGA number must accompany all returns. Returns must be sent freight prepaid unless we have agreed in writing to issue a call tag.
- 4.** Minimum order: one (1) piece. A \$10.00 handling fee applies to orders valued at less than \$50.00 net.
- 5.** Samples: up to three samples (three different items) are provided free of charge. Shipping charges apply. Sample orders from \$25.00 to \$50.00 net will be memo invoiced and credited to a subsequent order of \$250.00 or more placed within 90 days. Sample orders of \$50.00 or more will be invoiced at suggested retail prices minus applicable discount.
- 6.** Prices: prices in this catalog are suggested retail prices per piece and are subject to change without notice.
- 7.** Claims: shortages, damages or discrepancies between ordered and received items of any kind must be reported to Schwinn within 48 hours from the date the shipment was received. Schwinn is not responsible for damage to merchandise caused by the delivery carrier.
- 8.** Our craftsmen and finish experts strive to maintain consistent quality in all of our products. Variations in finish color, sheen, and texture occur naturally and do not constitute a defect. The specific range of variation depends on the finish process and material. We do not guarantee the match of a finish to a sample, different model, or different production runs.

Leather is a natural product from animal hides and therefore differs from hide to hide. Variations in the texture of the leather should not be considered a fault but inherent of the natural beauty and uniqueness of the leather. As every piece of leather is different and may accept dyes a little differently during the tanning process, this may cause irregularities in the consistency and depth of the color. Markings such

as dents, scars, scratches, wrinkles or blemishes occur naturally in leather. These irregularities should not be considered as a defect but rather indications of genuine leather.

Stainless steel grade 303, the grade commonly used in cabinet hardware for its machinability, should not be exposed to marine or other similar environments, as this will result in rapid pitting corrosion. Schwinn Performance Finish products provide maximum corrosion resistance, chemical resistance, as well as abrasion resistance in addition to their antimicrobial properties.

- 9.** Warranty: Schwinn warrants that its products are free from defects in workmanship and materials. Schwinn is not responsible for failure due to incorrect installation, failure to follow mounting instructions or use of product in a manner for which it was not designed. Failure due to abuse, misuse or accident, any failure due to dismantling, alteration, or repair by any person not authorized by Schwinn. Failure due to incorrect maintenance. Fair wear and tear. Cost of removal, installation and freight. Deterioration and discoloring of finishes over time due to climate conditions.

- 10.** Liability: Schwinn's liability hereunder is limited to the purchase price of the product. In no event shall Schwinn be liable for any consequential, indirect, incidental or special damages of any nature arising from the sale or use of the product, whether in contract, tort, strict liability or otherwise.

- 11.** Screws: all our handles and knobs require the use of metric screws. If "cut-off" screws are used: these screws can be cut at specific increments to accommodate the most common panel thicknesses. Please use end cutting or side cutting pliers and cut at specific increments only. Improperly cut screws will damage the tapping in the handle or knob.

- 12.** Care of hardware: please use a damp, non-abrasive cloth or sponge and mild soap only.

- 13.** Displays: a high quality display program for showrooms with sample boards for wall or free-standing presentation is available upon request.

Design Credits
© Schwinn Hardware, Inc.
Design: Schwinn Hardware, Inc.
Schwinn Hardware, Inc. Kluegel Schwinn Beschlaege, www.schwinnhardware.com, the Schwinn logo and Schwinn's distinctive product names are exclusive proprietary trademarks of Kluegel Schwinn Beschlaege GmbH. All other trademarks, product names, designer names and company names are the property of the respective owners.

5/8" 16 mm

1 1/4" 32 mm

1 7/8" 48 mm

2 1/2" 64 mm

3 3/4" 96 mm

5" 128 mm

6 5/16" 160 mm

7 1/2" 192 mm

8 13/16" 224 mm

10 1/16" 256 mm

SCHWINN

Your new tool
to select the
perfect hardware.



NEW Schwinn Design Assistant®

All designs in one tool. Use it like samples. Hold up to the cabinet and see how it looks. Front view. Top view. Actual size images. All specification details. Selecting hardware has never been easier. Order Nr. 59034

www.schwinnoriginals.com