

REVISIONS		
ZONE	REV	FINISHES:
		PB, AB, BZ, 10B & S
		GALUGE:
		22ga. .032

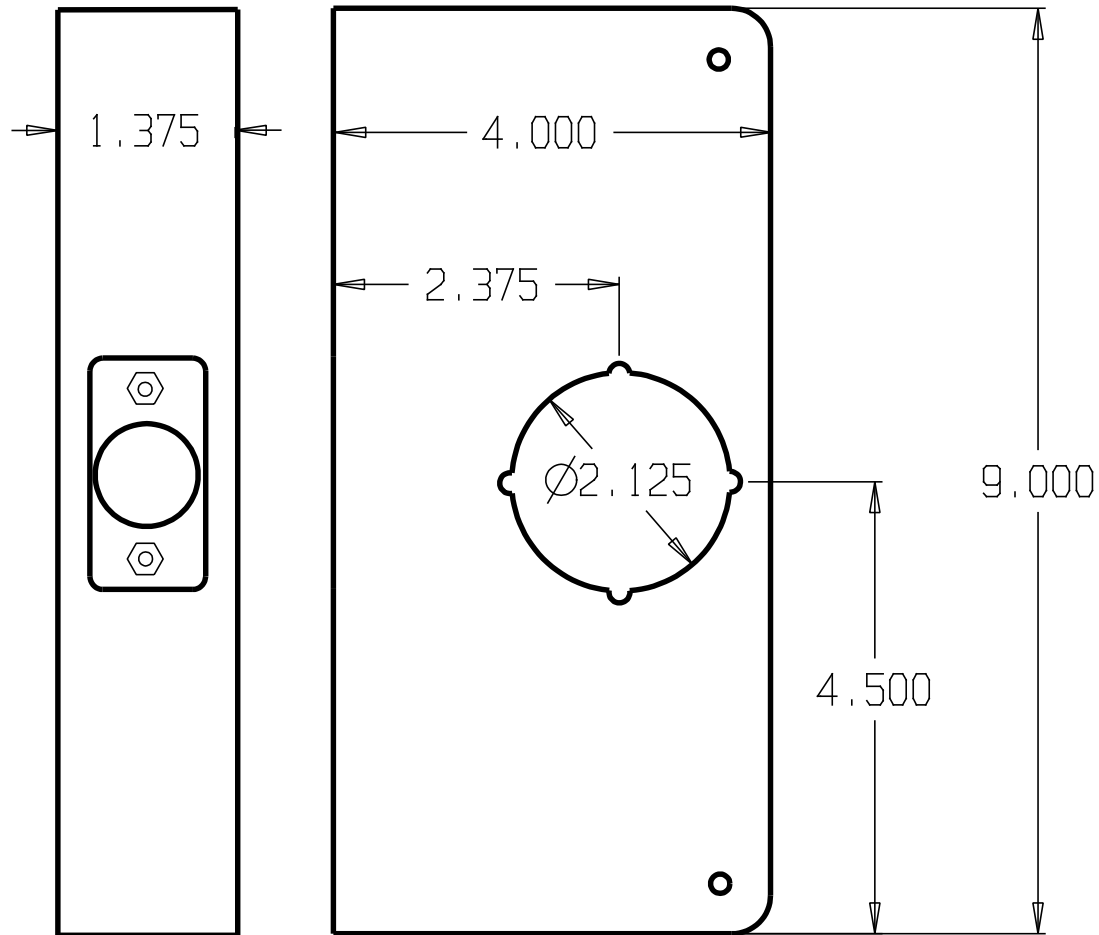

DON-JO MFG. INC.

DESIGNER	
APPROVED	

SIZE	DATE:	PART NO.	REV
A	1/1/94	1-CW	
SCALE	RELEASE DATE	WEIGHT	SHEET