

REVISIONS				
ZONE	REV	FINISHES:	DATE	APPROVED
		PB, AB, BZ, 10B & S		

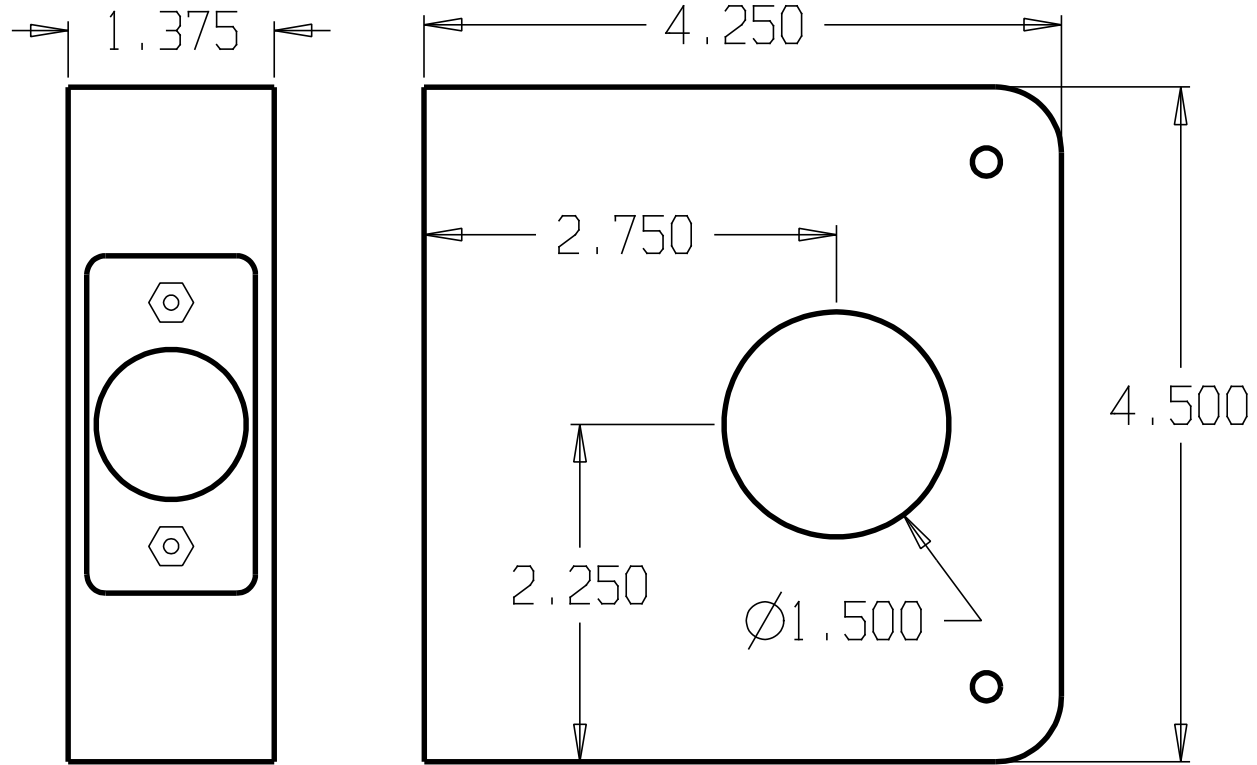

DON-JO MFG. INC.				
DESIGNER	SIZE	DATE:	PART NO.	REV
	A	4/28/04	7-CW	
APPROVED	SCALE	RELEASE DATE	WEIGHT	SHEET